

eurocell

WINDOW & DOOR SOLUTIONS



**EXCLUSIVE
TRADE DEALS
AVAILABLE**

Ask in branch
for more details

aspect

charisma

syncro

dales doors

logik

studioglide

modus

WINDOWS, DOORS & HARDWARE

PRODUCT RANGE

WINDOW RANGE	4
MODUS WINDOWS	6
LOGIK WINDOWS	8
CHARISMA VERTICAL SLIDERS	10
WINDOW FINISHINGS	13
ROOFLIGHTS	35
DOORS	45
DALES COMPOSITE DOORS	46
ELEGANCE PVC-U DOORS	54
SYNCRO SLIDING PATIO DOORS	60
ASPECT PVC-U BI-FOLD DOORS	62
STUDIOGLIDE ALUMINIUM BI-FOLD DOORS	64
FRENCH DOORS	66
GARAGE DOORS	70
HARDWARE	73



HARDWARE 73



DOORS 45



GARAGE DOORS 70



BI-FOLD AND PATIO DOORS 60



WINDOW RANGE 4



Over 6000 products in branch



200+ branches nationwide



Product experts in every branch



Free surveys & quotations



Click & collect in branch



Free onsite delivery*

*Longer lead times apply to made-to-order items. Applies to mainland UK only and excludes Northern Ireland & Northern Scotland. Minimum order value of £50.

EUROCELL WINDOWS & DOORS FROM EUROCELL BRANCHES

**READY TO COLLECT IN BRANCH
IN JUST 7-14* WORKING DAYS**

IT'S A NO BRAINER!

SAVE TIME & MONEY

When you're buying Eurocell roofline products from your local branch, make sure you pick up your windows too! Whether you're looking for traditional casement windows, fully-engineered vertical sliding sash windows or our advanced tilt and turn windows, they're all in one place – saving you time and money!

MARKET LEADING WINDOWS – IN BRANCH NOW!

You'll find outstanding performance right across the range. With a choice of styles, colours and finishes to suit every building, our innovative windows boast A++ energy ratings and U-values as low as 0.8. In other words, they exceed the latest energy-efficiency standards.

FULLY GUARANTEED

Windows bought from your local branch are covered by a 10 year guarantee.

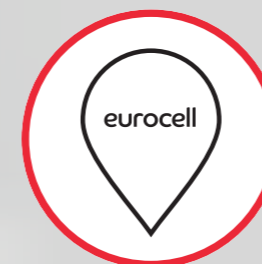
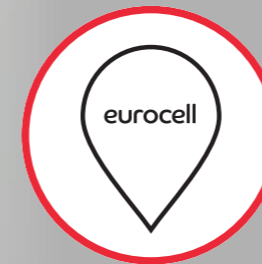

**FIND YOUR LOCAL BRANCH AT
eurocell.co.uk/branchfinder**

*We aim to get these to you within the specified time frame, but there may be instances when this lead time may be extended

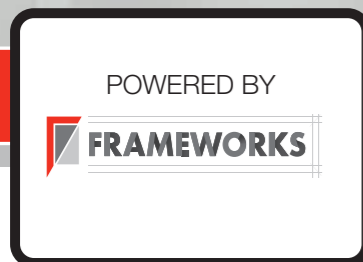

GET INSTANT QUOTES

Visit your local branch today to get quotes in an instant on a full range of windows and doors.



Modus features a clean, contemporary look with slim sightlines and leading thermal performance. Containing 50%* post-consumer recycled UPVC as standard, Modus is our most sustainable profile.

8 Systems in 1:

- Standard sash casement
- Slim rebate sash casement
- Flush sash casement
- Reversible windows
- Tilt and Turn windows
- Entrance doors
- French doors
- Composite door frame

*Average – post-consumer and virgin UPVC % content varies between profiles

Features & Benefits

- Outstanding technical performance** (Icon: Medal with checkmark)
- Fast, accurate fabrication and installation** (Icon: Clock with circular arrows)
- Superb energy efficiency performance** (Icon: A++ FOR WINDOWS)
- U-values as low as 0.8*** (Icon: U0.8 WITH ARGON GAS)
- BBA certified system** (Icon: BBA APPROVED logo)
- Market-leading sustainability** (Icon: Leaf with circular arrows)
- Wide range of colour and style options** (Icon: Colour palette)
- 12-year guarantee for peace of mind**** (Icon: 12 YEAR)

* Lower U-values are achievable with Krypton gas. ** White profiles only









Style & Colour Options

WHITE White interior	WHITE ASH Both sides	CREAM WHITE White interior	AGATE GREY White interior	ANTEAK White interior	ROSEWOOD White interior	IRISH OAK White interior	BLACK ASH White interior
ANTHRACITE GREY* White interior	SLATE GREY White interior	MOONDUST GREY White interior	32 Additional colours and specifications are made to order on extended lead times				





Features & Benefits

 <p>Outstanding technical performance</p>	 <p>Fast, accurate fabrication and installation</p>	 <p>Superb energy efficiency performance</p>	 <p>U-values as low as 0.9*</p>
 <p>BBA certified system</p>	 <p>Market-leading sustainability</p>	 <p>Wide range of colour and style options</p>	 <p>10-year guarantee for peace of mind</p>

* Lower U-values are achievable with Krypton gas.



Ovolo

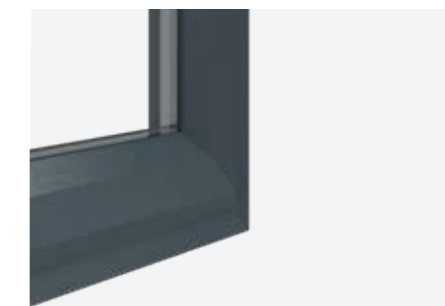

Chamfered













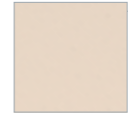



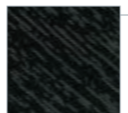

Flush Sash

The Logik profile system combines leading energy efficiency performance and aesthetics with ease of use, for the ultimate system.

Available in chamfered, flush or ovolo styles as:

- Standard casement
- Flush casement
- Tilt and Turn
- French windows
- Residential doors
- French doors

Frame colours from stock

							
WHITE White interior	CREAM WHITE† White interior	WHITE ASH† White interior	WHITE ASH† White Ash interior	AGATE GREY† White interior	ANTHRACITE GREY White interior	ANTHRACITE GREY Grey interior	SLATE GREY** White interior
							
BLACK ASH White interior	IRISH OAK† White interior	IRISH OAK† Irish Oak interior	GOLDEN OAK White interior	GOLDEN OAK Golden Oak interior	ROSEWOOD† White interior	ROSEWOOD† Rosewood interior	CHARTWELL GREEN White interior
			32 Additional colours and specifications are made to order on extended lead times				
DARK RED‡ White interior	BLUE‡ White interior	OLIVE GREEN‡ White interior	† Ovolo only ** Chamfered only ° Door frame only Note: grey base product features cool colours foil				









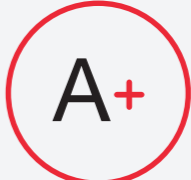

Offer your customers classically styled traditional windows with all the low-maintenance and thermal efficiency benefits of modern PVC-U.

With traditional styling, slim sightlines and a host of decorative finishing touches, they echo the elegance of the Georgian era. Optional ovolo Georgian bars and ovolo crash stops co-ordinate with the sculpted frames to give a classic cottage look, which is enhanced by decorative horns. Slot-in end caps for Georgian bars and security bars are sculpted to fit flush with the window frame, removing any need for difficult and time-consuming milling. A unique Georgian bar cruciform moulding creates a neat finish at the crossing point of vertical and horizontal bars. As well as sliding up and down, both sashes in the window also tilt inwards. This innovative slide-and-tilt slide mechanism means that the outer glass panes can be cleaned safely and easily from within the building.







Features & Benefits

 <p>Outstanding technical performance</p>	 <p>Fast, accurate fabrication and installation</p>	 <p>Superb energy efficiency performance</p>	 <p>U-values as low as 1.3*</p>
 <p>Heritage specification available</p>	 <p>BBA certified system</p>	 <p>Wide range of colour and style options</p>	 <p>10-year guarantee for peace of mind</p>

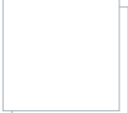
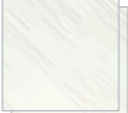
* Lower U-values are achievable with Krypton gas.

Frame Colours

						
WHITE White interior	WHITE ASH Both sides	CREAM WHITE† White interior	CREAM WHITE† Both sides	ROSEWOOD White interior	ROSEWOOD† Both sides	ANTHRACITE GREY White interior

Additional colours and specifications are made to order on extended lead times



Window finishing

CONTENTS

Cavity closers	14
Overhead vent	18
Glass & bridge packers	19
Window cills & accessories	20
Cill repair covers	24
Bow window accessories	25
Window boards	26
Finishing trims	29
Cosmetic repairs	33

From cavity closers to trims to window boards, our window finishing range allows you to get the perfect finish – for every job!

- **Cavity closers**
Close cavities quickly and effectively with our range of Cavalok closers, whilst improving thermal efficiency for homeowners - find out more on page 14
- **Intelligent 150mm cill**
The 150mm cill system has the flexibility to create larger sizes (up to 225mm) and accommodate project tolerance discrepancies through the use of various trims - find out more on page 20
- **Laminated window boards**
These scratch-resistant boards add the finishing touch to your window installation - find out more on page 26

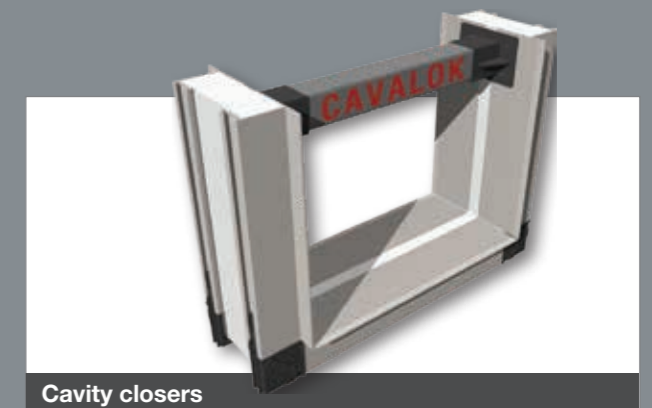

Cavity closers



Intelligent cills



Laminated window boards

What is a cavity closer?

cavity closer

A cavity closer is an energy-efficient aperture former which enables brick courses to be completed and creates an Air-tight receiver for windows and doors

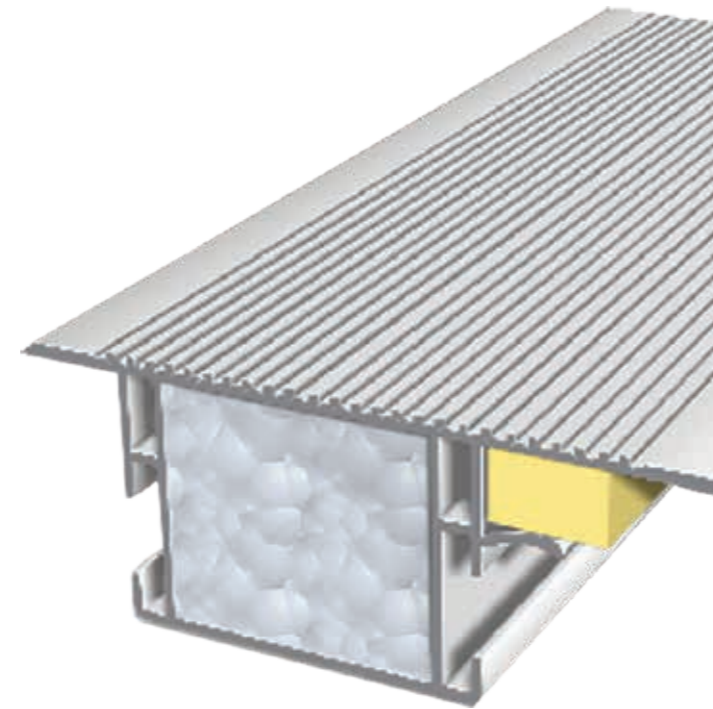

cavalok

Cavalok products are made from **100% recycled PVC-U**

BENEFITS

- Provides a damp proof course
- Simplifies brickwork - no return bricks needed
- Provides thermal break
- Stops cold bridging which can cause condensation to form inside the opening damaging internal decoration and plasterwork
- Improves heat loss at the window junction, reducing CO₂ emissions
- Meets Accredited Construction Details regulation designed to improve the heat loss at junctions
- Meets needs of Part L of the Building Regulations

WHICH PRODUCT IS RIGHT FOR YOU?

CAVALOK UNIVERSAL CAVITY CLOSER

- For cavity sizes 50-100mm
- Use for new build projects
- Cavity closer is assembled into a window template
- Ensures window manufacturer can produce to correct sizes without repeated surveying - saving time and money by reducing rework or snagging
- Easy to install, use with standard plastic ties to fix into coursework as you build

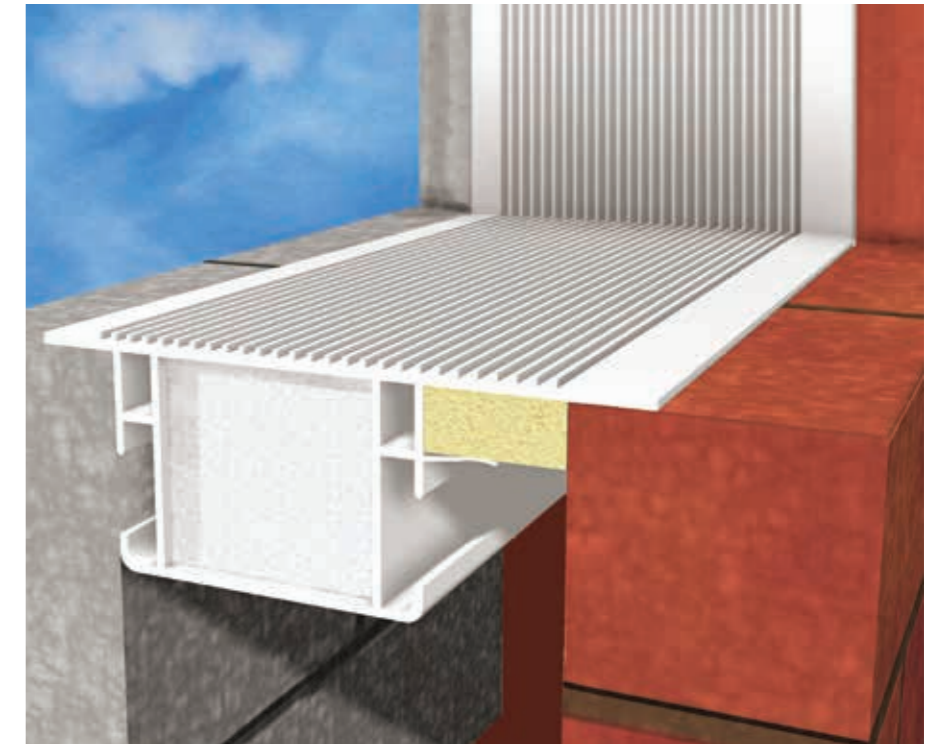

CAVALOK BIG BLOK CAVITY CLOSER

- For cavity sizes 125-300mm
- Use for new build projects
- Cavity closer is assembled into a window template
- Super-insulating, specially designed to meet the Code for Sustainable Homes
- Easy to install, use with standard plastic ties to fix into coursework as you build



*MTO - Max 150mm from stock.

GET A TRADE ACCOUNT TODAY

ASK IN BRANCH FOR MORE DETAILS



over 6000 products in branch



200+ branches nationwide

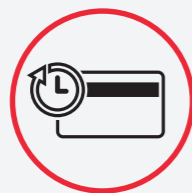

Trade credit available*



Dedicated account manager



Exclusive trade account pricing



Online trade account

* Trade accounts are subject to T&Cs and acceptance.

Cavity closer



CAVITY CLOSER SECTIONS

Trade closer



- This is a stand alone product - no extra components or assembly required!
- Suitable for applications between 50mm and 100mm

Code	Qty
MCBP TDR 100 HOR	10 pack

Window fixing strap

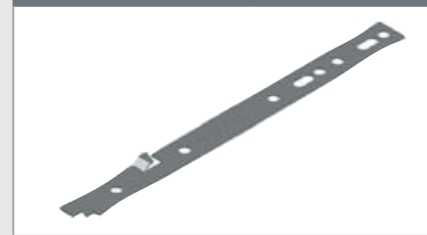

Code	Qty
CBPSTF7U2E	250 pack

Big Blok closer

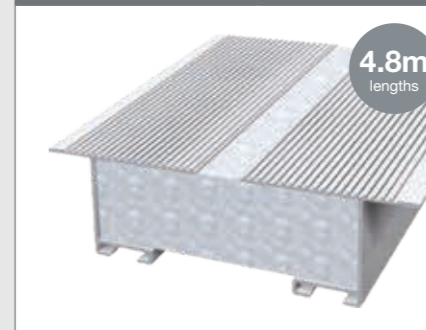

125mm closer (insulated)

Code	Size
MCBP 125 HOR 48	4 x 4.8m

150mm closer (insulated)

Code	Qty
MCBP 150 HOR 48	4 pack

Universal closer

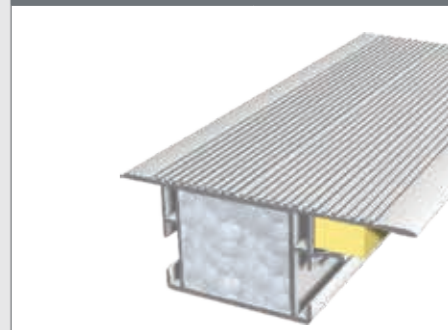

125mm closer (insulated)

Code	Qty
MCBP 050 HOR 48	6 pack

75mm closer (insulated)

Code	Qty
MCBP 075 HOR 48	6 pack

100mm closer (insulated)

Code	Qty
MCBP 100 HOR 48	6 pack

FRAME FORMING CORNERS

Cavalok corners



50mm	
Code	Qty
CBP CAV 50 MOU	100/box
75mm, 90mm, 100mm	
Code	Qty
CBP CAV 75 MOU 13	100/box

Big Blok corners



For use on all 125mm - 300mm cavity closers	
Code	Qty
CBP BB MOU	200/box

Big Blok corner fillet



For use on all 125mm - 300mm cavity closers	
Code	Qty
CBP BBS FIL	50 pack

FRAME FORMING BRACING

Brace bar

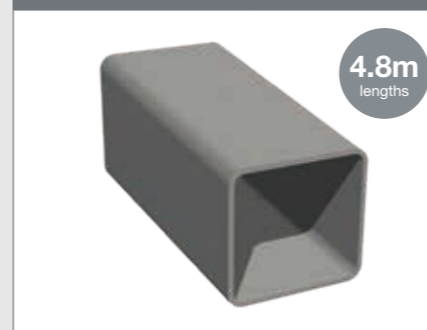

For use with both Cavalok and Big Blok closer

Code	Qty
MCBP CAV BR BOX	60 pack

Brace boot



For use with both Cavalok and Big Blok closer

Code	Qty
CBP BOOT 14	100/box

FRAME INSTALLATION

Brick ties

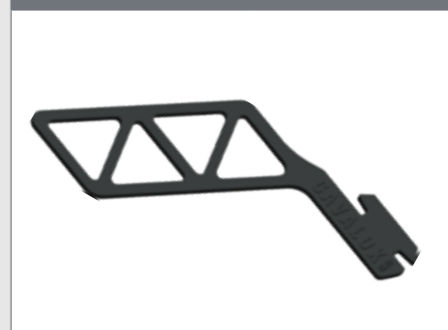

For use with both Cavalok and Big Blok closer

Code	Qty
CBP BB TIE	1000/box

Overhead vent

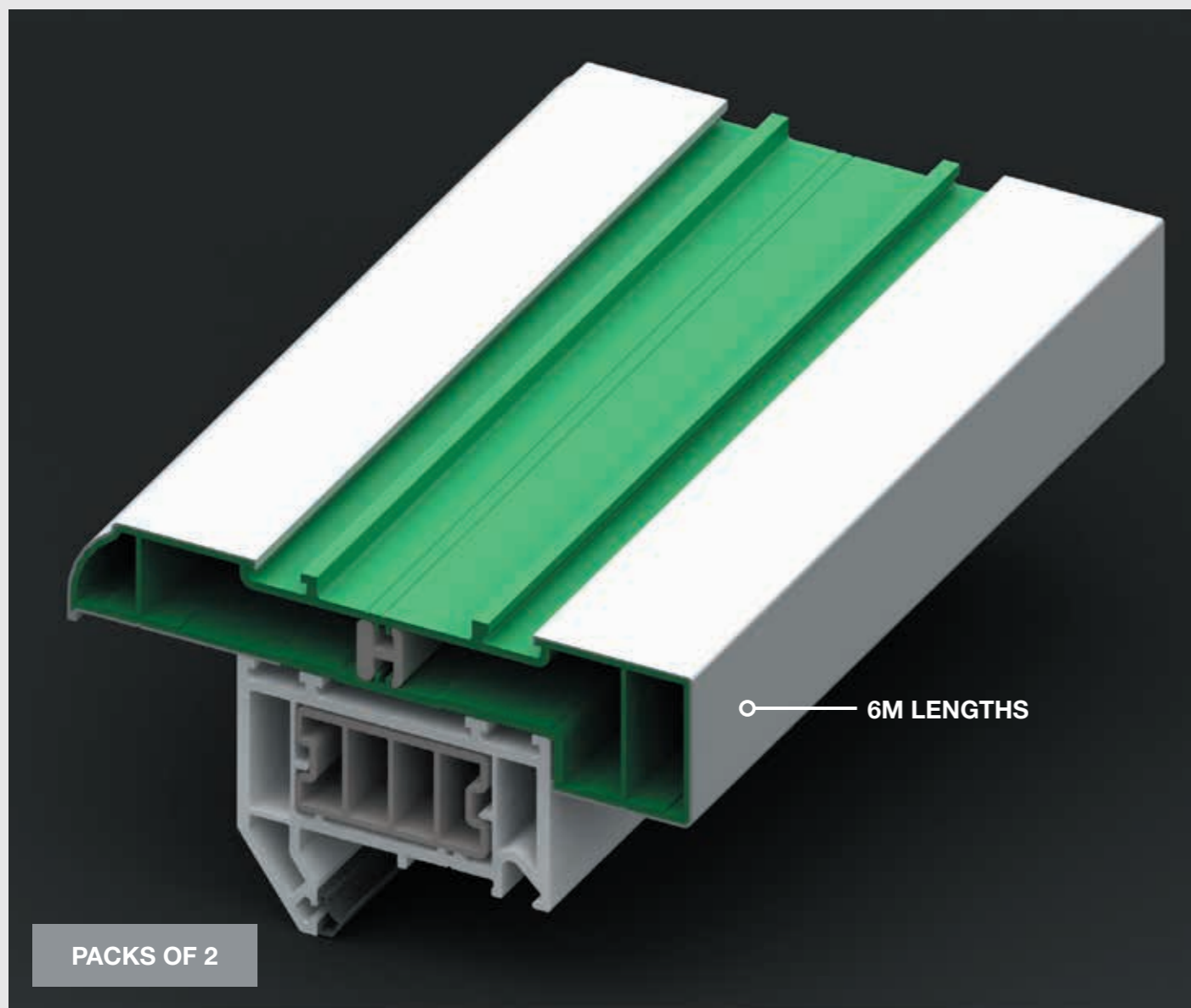

Universal head vent		
Code	Foil	Stock/MTO
EWS137W	N/A	STOCK
EWS137WGY1LF	Anthracite Grey LF	STOCK
EWS137WGY2SLF	Smooth Slate Grey LF	STOCK
EWS137WROLF	Rosewood LF	MTO
EWS137WOLF	Golden Oak LF	MTO
EWS137WGY2LF	Slate Grey LF	MTO
EWS137WGY1SLF	Smooth Anthracite Grey LF	MTO
EWS137WYLF	Black Ash LF	MTO
EWS137WT1LF	Chartwell Green LF	MTO
EWS137WCR1LF	Cream White LF	MTO
EWS137WZBF	White Ash BF	MTO

Designed to be used with frames with a front to back dimension of up to 80mm.

On the inside the vent has a square box detail which allows the head of the reveal to be double boarded without obstructing the ventilation path.

Head vent spacer		
Code	Foil	Qty
VSW105W	N/A	Pack of 50

TRICKLE VENTILATION



Trim vent and canopy		
Code	Size	Qty
TS VENT	XS 4400 EA ventilator (screw fix)	50 pack

COLOUR OPTIONS



WH WHITE



C CARAMEL



BR BROWN

GLASS & BRIDGE PACKERS

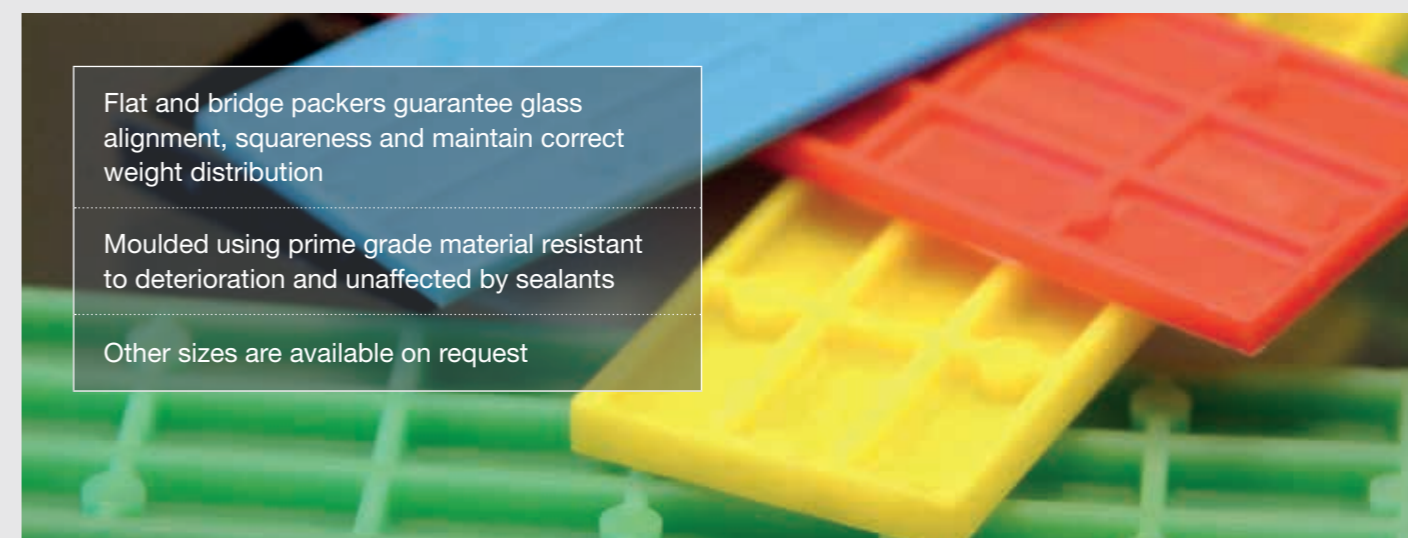

Flat and bridge packers guarantee glass alignment, squareness and maintain correct weight distribution

Moulded using prime grade material resistant to deterioration and unaffected by sealants

Other sizes are available on request

Bridge packers		
Code	Size	Qty
BRP283	100 x 28 x 3mm	1000 pk
BRP325	100 x 32 x 5mm	1000 pk

24mm glass packers		
Code	Size	Qty
PP24GP100	Mixed bag	100 pk
FL24F200	1-6mm mixed	200 pk

28mm glass packers		
Code	Size	Qty
FLWH28	100 x 28 x 1mm	1000 pk
FLBU28	100 x 28 x 2mm	1000 pk
FLRE28	100 x 28 x 3mm	1000 pk
FLYE28	100 x 28 x 4mm	1000 pk
FLGN28	100 x 28 x 5mm	1000 pk
FLBL28	100 x 28 x 6mm	1000 pk
PP28GP100	Mixed bag	100 pk
FL28FP200	1-6mm mixed	200 pk
FL28FP300	1-6mm mixed	300 pk

30mm glass packers		
Code	Size	Qty
FLRE30	100 x 30 x 3mm	1000 pk
FLGN30	100 x 30 x 5mm	1000 pk

32mm glass packers		
Code	Size	Qty
FLWH32	100 x 32 x 1mm	1000 pk
FLBU32	100 x 32 x 2mm	1000 pk
FLRE32	100 x 32 x 3mm	1000 pk
FLYE32	100 x 32 x 4mm	1000 pk
FLGN32	100 x 32 x 5mm	1000 pk
FLBL32	100 x 32 x 6mm	1000 pk
FL32FP200	1-6mm mixed	200 pk

Window cills & accessories

INTELLIGENT 150MM CILL SYSTEM

The cill provides solutions to issues commonly found on site

Allows flexibility to create larger sizes

Accommodates project tolerance discrepancies through the use of cill extender and frame extension trims

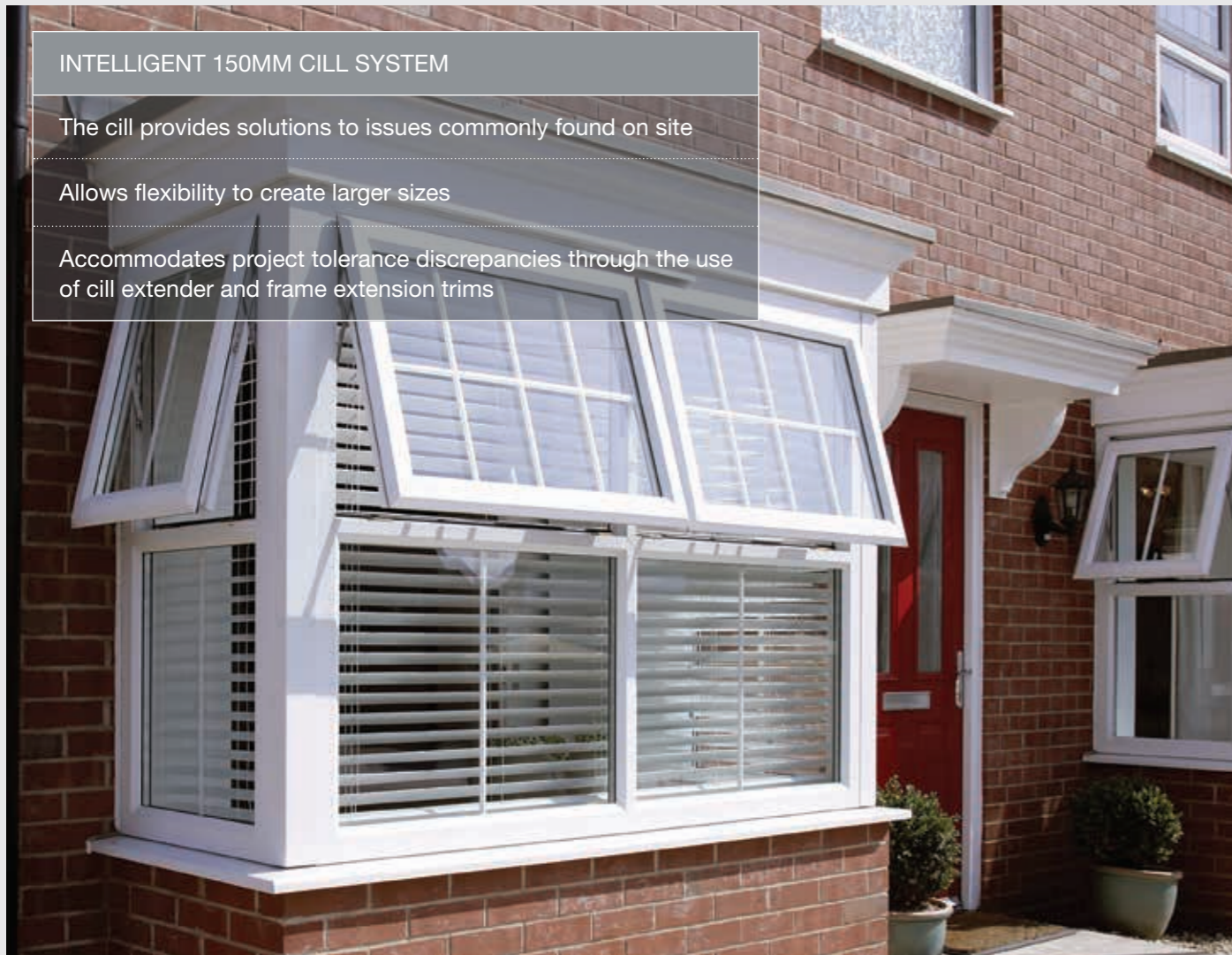

85mm A-type cill and end caps

Cill	End caps
Code	Code
AS 85	ECA 85
Colour options: WGY15S / 7016 / WY / CR / WCR1 / WO / WLO1 / CO / RO / 64 / WZ	Colour options: CO / CR / WG / O / 64



125mm A-type cill and end caps

Cill	End caps
Code	Code
AC125	ECA 125
Colour options: WGY15S / 7016 / CR / WCR1 / 7015 / 64	Colour options: 7016 / B / CO / CR / WCR1 / 7015 / 64



180mm A-type cill and end caps

Cill	End caps
Code	Code
AC180	ECA 180
Colour options: WY / CR / WO / WLO1 / CO / RO / 64	Colour options: 7016 / BK / B / BB / CO / CR / WCR1 / WG / O / 64

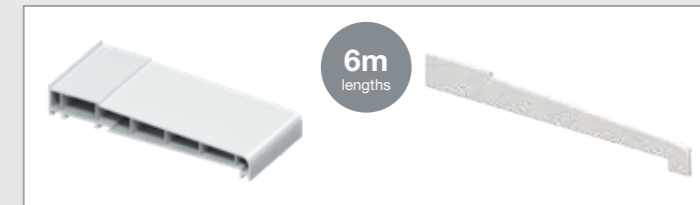

225mm A-type cill and end caps

Cill	End caps
Code	Code
AC 225	ECA 225
Colour options: WGY15S / CR / RO / 7015 / 64 / WZ	Colour options: 7016 / B / CO / RO / 7015 / 64

150mm A-type cill and end caps

Cill
Code
AC150
Colour options: 7016 / WY / CR / WCR1 / WO / WLO1 / CO / RO / 64 / WZ
End caps
Code
ECA 150
Colour options: 7016 / BK / B / BB / CO / CR / WCR1 / WG / O / 64

Combinations



CILL WITH EXTENDER
See EWS 118 (below)



CILL WITH 25mm EXTENDER TRIM
See EWS 106 (below)



CILL WITH 10mm EXTENDER TRIM
See EWS 136 (below)



See page 22 for colour swatches

Window cills & accessories

COLOUR OPTIONS

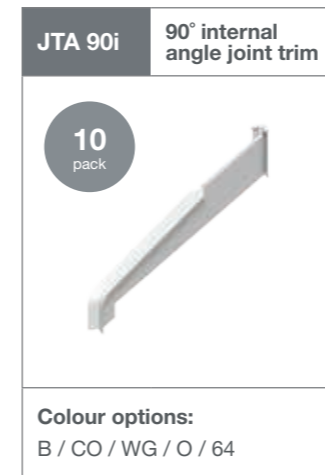
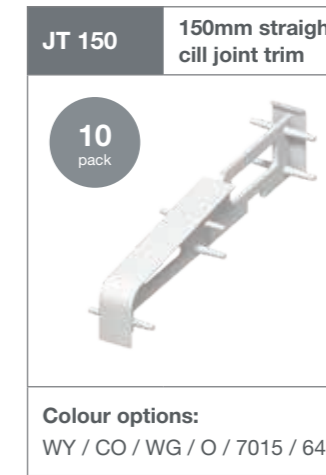

Cill repair covers

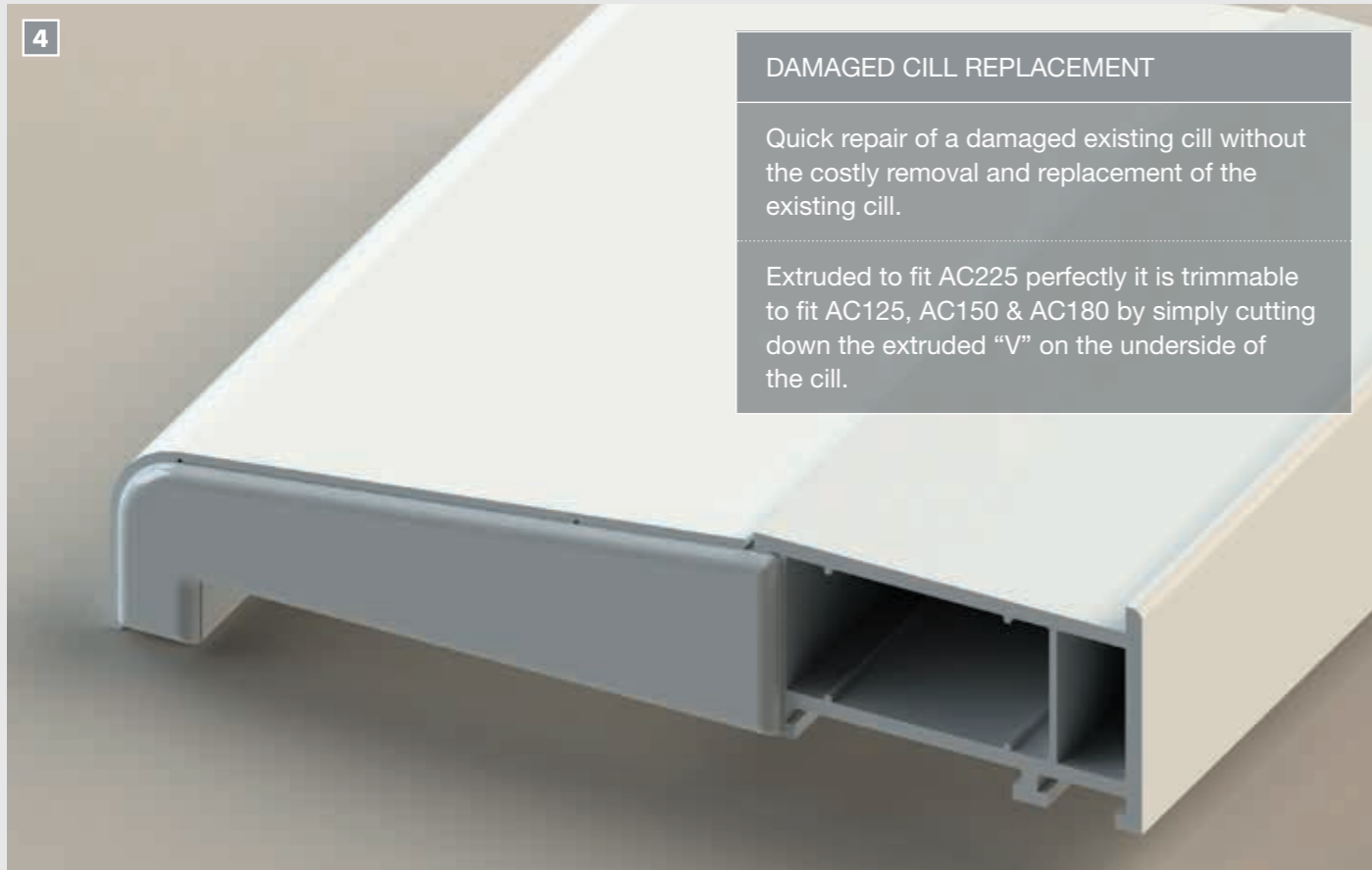
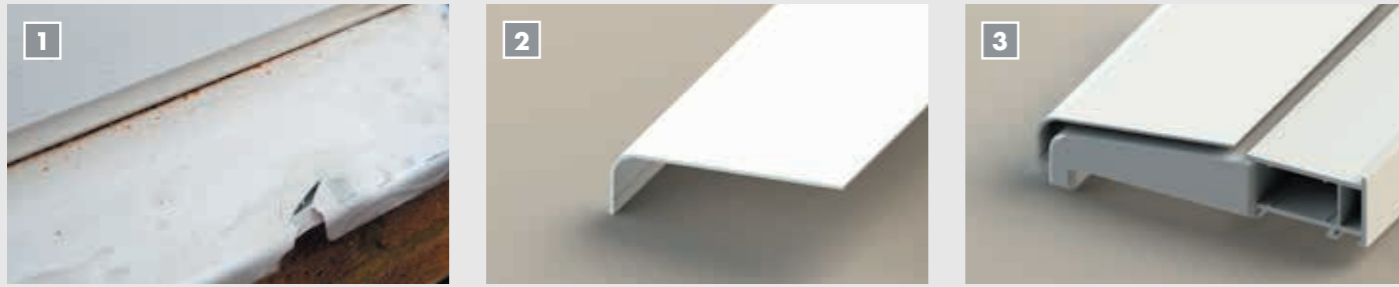

DAMAGED CILL REPLACEMENT

Quick repair of a damaged existing cill without the costly removal and replacement of the existing cill.

Extruded to fit AC225 perfectly it is trimmable to fit AC125, AC150 & AC180 by simply cutting down the extruded "V" on the underside of the cill.

Cill cover repair				
Code	Size	Qty	Colour	
			Base	Foil
EWS119W	5m x 3.7m	5 pack	white	N/A
EWS119WO	5m x 3.7m	5 pack	white	Golden Oak
EWS119WRO	5m x 3.7m	5 pack	white	Rosewood
EWS119WGY1	5m x 3.7m	5 pack	white	Anthracite Grey

PERFECT PARTNER

With
SOUDALL SUPERGLUE
and **SOUDALL**
ACTIVATOR.



Bow window accessories



CREATE A PRESTIGIOUS LOOK WITH CANOPIES AND BASE UNITS FOR BOW WINDOWS

CANOPY

BASE UNIT

Bow canopies			
<ul style="list-style-type: none"> • Quick and easy installation • One piece leak-proof moulding • Available with lead-look top • Made from strong rigid fibreglass • Maintenance-free 			
Standard			
Code	Size	Qty	
BC 18	1.8m	1 pack	
BC 24	2.4m	1 pack	
Foam filled			
Code	Size	Qty	
BC 18 FF	1.8m	1 pack	
BC 24 FF	2.4m	1 pack	

Bow units			
<ul style="list-style-type: none"> • Quick and easy installation • Fully moulded GRP base unit including attached gallows bracket • Made from strong rigid fibreglass giving a firm foundation for a bow window 			
Standard			
Code	Size	Qty	
BA18 MK1	1.8m	1 pack	
BA18 MK1	2.4m	1 pack	

Gallows brackets	
Code	Size
GB 7.5	7.5"
GB 10	10"
GB 713	2.4m

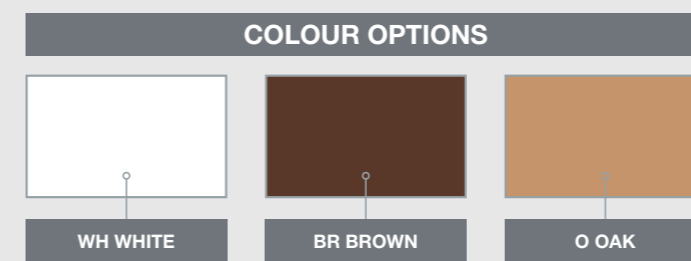

Window boards

23mm laminated window boards - standard range

Code	Size	Qty
WT150	150mm x 5m	1 pack
WT200	200mm x 5m	1 pack
WT225	225mm x 5m	1 pack
WT250	250mm x 5m	1 pack
WT300	300mm x 5m	1 pack
WT600	600mm x 3m	1 pack
WT900	900mm x 3m	1 pack



Colour options:
 WH White / RW Rosewood / GO Golden Oak / LO Light Oak
 /CR Cream* / WZ White Ash* / GY Anthracite Grey (MTO)
 (*Except WT 300, WT 150 WT 180)

STANDARD RANGE COLOURS AVAILABLE

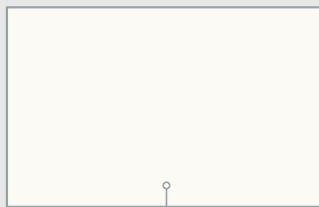

WHITE (WH)

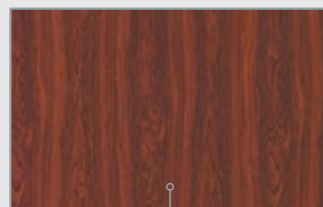

ROSEWOOD (RW)

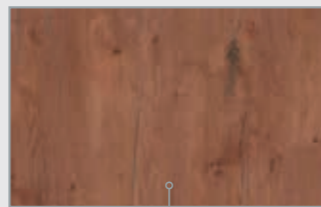

GOLDEN OAK (GO)



LIGHT OAK (LO)

23MM LAMINATED WINDOW BOARDS

23mm laminated window boards - designer range

Code	Size	Qty
WT250	4100mm x 250mm	1 board
WT600	3000mm x 600mm	1 board
WT900	3000mm x 900mm	1 board

More sizes available on made to order



DESIGNER RANGE COLOURS AVAILABLE

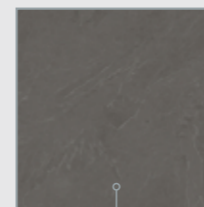

GREY ITALIAN SLATE (GIS)



BOSTON CONCRETE (BC)



WHITE PAINTED OAK (WPO)

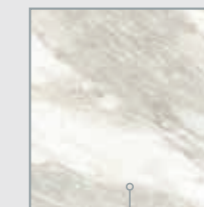

VENATO MARBLE (VM)

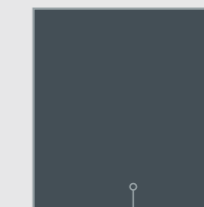

ANTHRACITE (AG)

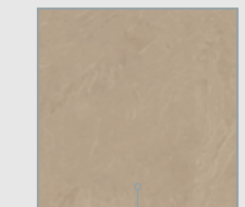

CREAM ITALIAN SLATE (CIS)



23MM LAMINATED TRIM

WTFEC Laminated end cap



Foil options:
 WH White / ROF Rosewood /
 OF Golden Oak / WG Brown /
 LO2F Light Oak / CR Cream /
 AG Anthracite Grey / LG Light Grey /
 MG Medium Grey

WTJT Laminated joint trim

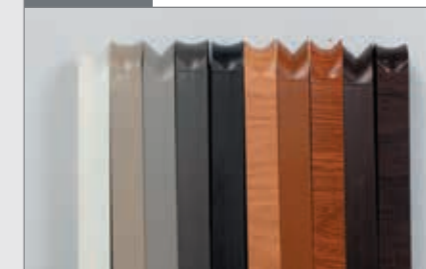

Foil options:
 WH White / ROF Rosewood /
 OF Golden Oak / WG Brown /
 LO2F Light Oak / CR Cream /
 AG Anthracite Grey / TK Teak /
 LG Light Grey / MG Medium Grey

WTUT Laminated universal trim

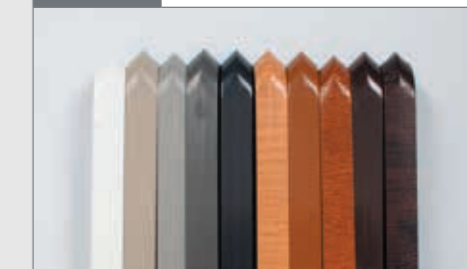

Foil options:
 64 White / RW Rosewood / WO Golden
 Oak / WG Brown / LO2F Light Oak /
 CR Cream / C Caramel / B Brown /
 AG Anthracite Grey / LG Light Grey /
 MG Medium Grey

9MM WINDOW BOARDS



9mm window boards		
Code	Size	Qty
WB160	160mm x 5m	2 pack
WB180	180mm x 5m	2 pack
WB210	210mm x 5m	2 pack
WB240	240mm x 5m	2 pack
WB260	260mm x 5m	2 pack
WB420	420mm x 5m	1 pack
Colour options: 64 White		

finishing trims

EXPANDED TRIMS COLOURS RANGE

To enhance the current range of colours, our window trims* will be available in four new foiled finishes. These are: **Chartwell Green, Slate Grey, Moondust Grey and Anteak**

*Colour availability varies by product



9MM WINDOW BOARD ACCESSORIES

EWS129 Window board retaining trim
2 pairs

6m lengths

Colour options:
W White / RWO Rosewood / WO Golden Oak

EWS229 Window board retainer end cap
2 pairs

2 pairs

Colour options:
W White / BRO Rosewood / CR Cream / CO Oak

DEC Long end caps
10 pairs

10 pairs

Colour options:
64 White / O Golden Oak / WG Brown

EWBECS Short end caps
5 pairs

5 pairs

Colour options:
64 White

EXAMPLES OF USE



PENCIL ROUND ARCHITRAVE

This flatback pencil-round architrave hides minimal plaster damage, whilst providing an attractive finish. Available in 3 sizes.



25MM D MOULDING

Conceal window joins with a 25mm D-moulding trim to improve sightlines and create a clean, colour-matched finish.



FOAM QUADRANT

Neaten joins with attractive foam quadrants, available in a variety of colours. Suitable for use around windows, floors and more.

Finishing trims

20
x 5m



Bead

Code	Size
B20	20mm

Colour options:
64 White, WO Golden Oak, RO Rosewood, WZ White Ash, 7016 Anthracite Grey, WY Black Ash, BW Blue White, WT1 Chartwell Green*, CR1 Cream White*, GY4 Agate Grey*, WG Woodgrain, WG Woodgrain Brown

10
x 5m



20mm square

Code	Size
S20	20mm

Colour options:
64 White, WO Golden Oak, RO Rosewood, 7016 Anthracite Grey, GY1S Anthracite Grey Smooth, WY Black Ash, WG Woodgrain

20
x 5m



25mm D moulding

Code	Size
D25	25mm

Colour options:
64 White, CR Cream, WO Golden Oak, RO Rosewood, WLO1 Irish Oak, WZ White Ash, 7016 Anthracite Grey, GY1S Anthracite Grey Smooth, WY Black Ash, BW Blue White, WT1 Chartwell Green, CR1 Cream White, 7015 Slate Grey, WGY2S Slate Grey Smooth, GY4 Agate Grey, LO10 Anteak, GY17 Balmoral*

20
x 5m

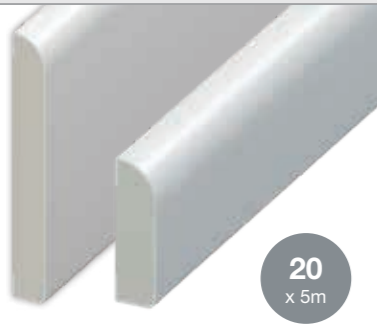

Cloaking fillet

Code	Size
C20	20mm

Colour options:
64 White, CR Cream, WO Golden Oak, RO Rosewood, WLO1 Irish Oak, WZ White Ash*, 7016 Anthracite Grey, GY1S Anthracite Grey Smooth, WY Black Ash, BW Blue White, WT1 Chartwell Green*, CR1 Cream White, GY3 Moondust Grey*, 7015 Slate Grey, WGY2S Slate Grey Smooth, GY4 Agate Grey*, LO10 Anteak*, GY17 Balmoral*

Code	Size
C30	30mm

Colour options:
64 White, RO Rosewood, WLO1 Irish Oak, WZ White Ash*, 7016 Anthracite Grey*, GY1S Anthracite Grey Smooth, WY Black Ash, BW Blue White, WT1 Chartwell Green, CR1 Cream White, 7015 Slate Grey, WGY2S Slate Grey Smooth, GY4 Agate Grey*, LO10 Anteak*, GY17 Balmoral*

20
x 5m



13 or 17.5mm quadrant

Code	Size
Q13	13mm

Colour options:
64 White, CR Cream, WO Golden Oak, RO Rosewood, WLO1 Irish Oak, WZ White Ash, 7016 Anthracite Grey*, GY1S Anthracite Grey Smooth, WY Black Ash, BW Blue White, WT1 Chartwell Green, CR1 Cream White, 7015 Slate Grey, WGY2S Slate Grey Smooth, GY4 Agate Grey*, LO10 Anteak*, GY17 Balmoral*

Code	Size
Q175	17.5mm

Colour options:
64 White, CR Cream, WO Golden Oak, RO Rosewood, WLO1 Irish Oak, WZ White Ash, 7016 Anthracite Grey*, GY1S Anthracite Grey Smooth, WY Black Ash, BW Blue White, WT1 Chartwell Green, CR1 Cream White, 7015 Slate Grey, WGY2S Slate Grey Smooth, GY4 Agate Grey*, LO10 Anteak*, GY17 Balmoral*

PERFECT PARTNER

Seal trims with
SODAL SILIRUB LMN.



Look in branch for full range

ARCHITRAVES

5m
lengths



Ogee architrave Castellated

Code	Size	Qty
OGEE50	40mm x 5m	10 pack

Colour options:
64 White

5m
lengths

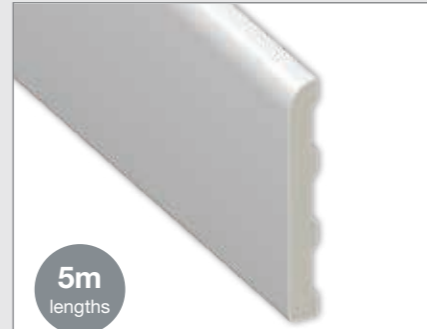

Pencil round architrave Castellated

Code	Size	Qty
PR40	40mm x 5m	10 pack

Colour options:
64 White

Code	Size	Qty
PR60	60mm x 5m	10 pack

Colour options:
64 White

Code	Size	Qty
PR90	90mm x 5m	10 pack

Colour options:
64 White

5m
lengths



Pencil round architrave Flat











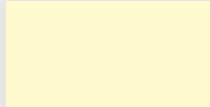



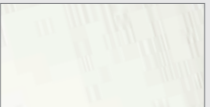
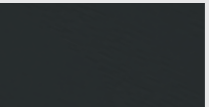

Code	Size	Qty
PF45	45mm x 5m	10 pack
PF65	65mm x 5m	10 pack
PF95	95mm x 5m	10 pack

Colour options:
64 White, CR Cream, WO Golden Oak, RO Rosewood, WLO1 Irish Oak, WZ White Ash, 7016 Anthracite Grey, GY1S Anthracite Grey Smooth, WY Black Ash, BW Blue White, WT1 Chartwell Green, CR1 Cream White, GY3 Moondust Grey*, 7015 Slate Grey, WGY2S Slate Grey Smooth, GY4 Agate Grey*, LO10 Anteak*, GY17 Balmoral*

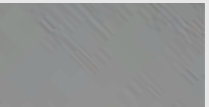
Code	Size	Qty
PF125	125mm x 5m	10 pack

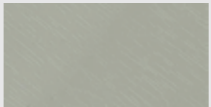
Colour options:
64 White, RO Rosewood, 7016 Anthracite Grey, WO Golden Oak, WY Black Ash

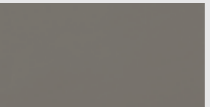
COLOUR AVAILABILITY

											
64 White	CR Cream	WO Golden Oak	RO Rosewood	WLO1 Irish Oak	WZ White Ash	7016 Anthracite Grey	GY1S Anthracite Grey Smooth				
											
WY Black Ash	BW Blue White	WT1 Chartwell Green	CR1 Cream White	GY3 Moondust Grey	7015 Slate Grey	WGY2S Slate Grey Smooth	GY4 Agate Grey	LO10 Anteak	GY17 Balmoral	WG Woodgrain Brown	* Made to order

Finishing trims

ANGLES

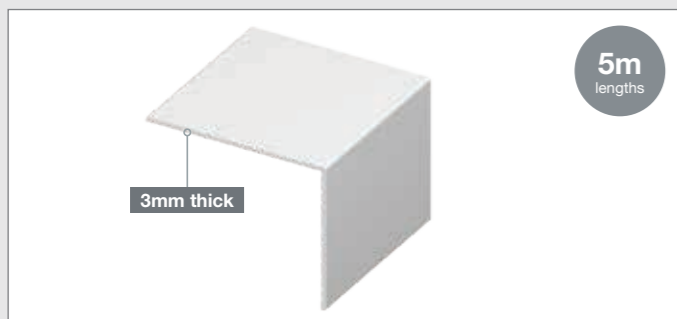

Rigid angles

Code	Size	Qty
RA 2525	25mm x 25mm	20 pack
RA 6060	60mm x 60mm	5 pack
RA 8080	80mm x 80mm	5 pack
RA 1008	100mm x 80mm	5 pack

Colour options:
64 White / RO Rosewood / WO Golden Oak / WGY1 Anthracite Grey (*Except RA6060, RA8080 & RA1008) / WY Black Ash (*Except RA6060, RA8080 & RA1008)

GRA 4040	40mm x 40mm	20 pack
RA 6535	150mm x 35mm	10 pack

Colour options:
64 White / RO Rosewood / WO Golden Oak / WGY1 Anthracite Grey (*Except RA 6535) / WY Black Ash (*Except RA 6535)



3mm thick adjustable angles

Code	Size	Qty
AA 50	50mm x 5m	20 pack
AA 70	70mm x 5m	20 pack
GAA 100	100mm x 5m	15 pack

Colour options:
64 White / WRO Rosewood / WO Golden Oak / WGY1 Anthracite Grey / (*Except AA70 & GAA 100) WY Black Ash (*Except AA70 & GAA 100)

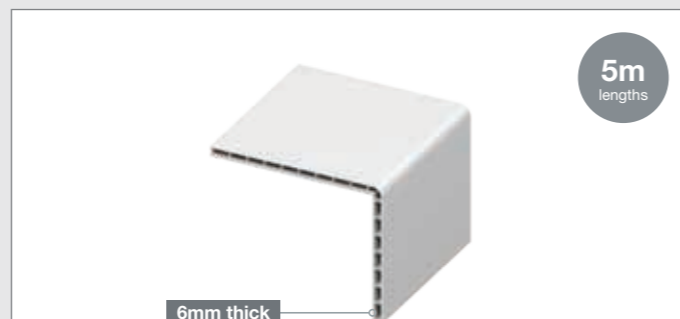

6mm thick hollow angles

Code	Size	Qty
HA 1008	100mm x 80mm	5 pack

Colour options:
64 White / RO Rosewood / WGY1 Anthracite Grey / WY Black Ash

DRAIN SLOT COVERS



Drain slot covers

Code	Colour
900300	White
900301	Brown
900303	Tan
900304	Anthracite grey
900305	Black
900306	Cream
078165SAND	Sand
8165/CG	Chartwell green

COSMETIC REPAIRS



COLOUR EDGING PENS

Replace missing colour on window seams, wooden flooring and more

- Unique press action
- Spare tips included
- Suitable for interior and exterior applications
- Original colour edging pen with pump action is also available

Code CEP



WINDOW REPAIR KIT

Successfully repair minor scratches to windows

- Suitable for repairing minor scratches, dents or bruises to PVC-U and timber windows
- Contains filler for use on Mahogany, Rosewood, Golden Oak and White profile
- Original colour edging pen with pump action also available

Code KO 614



COLOUR FILL & SOLVENT PACK

Effectively repairs laminate and melamine flooring

Code KO 614

Colour options:
64 White / RW Rosewood / WO Golden Oak / O Oak

YOU CAN NOW GET AN INSTANT PRICE FOR YOUR BESPOKE WINDOW IN BRANCH TODAY!

With the launch of our new Frameworks technology, we can provide you with an instant price at your local branch.

Ordering couldn't be easier - just let our branch staff know the window style, size, colour and quantity.

Get your quote today!



Rooflights & Roof Windows

ROOFLIGHTS

CONTENTS

Fakro pivoting windows	36
Luma	38
Rooflights	42
Flat roof windows	43

- **Fakro** pivoting roof window
Comes with inbuilt TopSafe Anti Burglary system, and Head ventilator as standard. P2 Glazing unit with toughened outer pane and laminated inner pane.
- **Luma** aluminium flat rooflights are made-to-measure and easy to install.
- **Rooflights** are an ideal way to increase natural light on flat roof properties.
- The **Fakro** type G product range includes flat roof windows which are non-opening (DXG), manually opening (DMG) or electrically operated (DEG)



Fakro pivoting roof windows

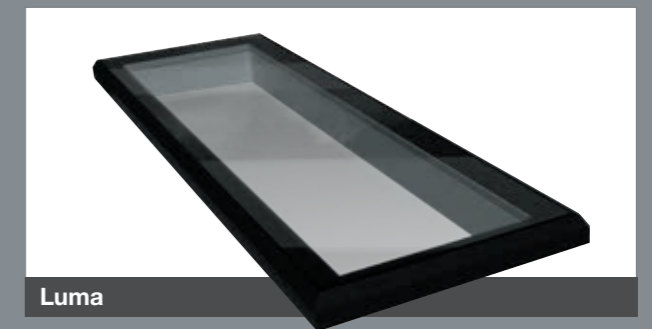

Luma

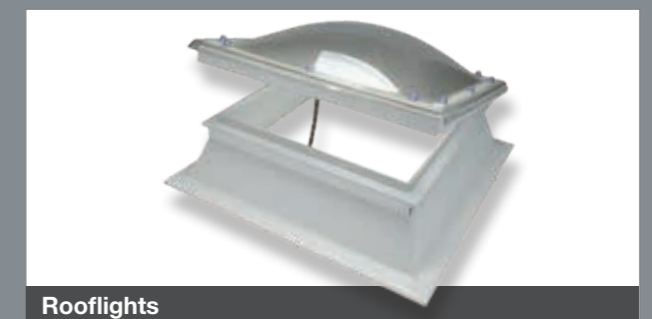

Rooflights



Flat roof windows

Roof windows

FAKRO PIVOTING ROOF WINDOW

Comes with inbuilt topSafe Anti Burglary system, and Head ventilator as standard. P2 Glazing unit with toughened outer pane and laminated inner pane.

Practical and stylish design

Suitable for 15-90 degree pitched roof

U Value of 1.3 W/m²K

Noise Reduction 32dB

Fire proof, Conforms with the European standards



FAKRO offer a complete range of premium quality innovative roof window solutions. From pivot roof windows in beautiful designs and clever opening methods, to flat roof windows in various designs and sizes. FAKRO also offer all the accessories needed to fit and furnish roof windows from exterior flashing to blinds.

A full range of compatible blinds and screens are available to order

ASK IN BRANCH FOR BLINDS AND ACCESSORY OPTIONS

FAKRO pivoting roof window

Code	Description
PTP-V01	Pivot Roof Window 55cm x 78cm
PTP-V02	Pivot Roof Window 55cm x 98cm
PTP-V05	Pivot Roof Window 78cm x 98cm
ELV01	Slate Flashing 55cm x 78cm
ELV02	Slate Flashing 55cm x 98cm
ELV05	Slate Flashing 78cm x 98cm
EZV01	Tile Flashing 55cm x 78cm
EZV02	Tile Flashing 55cm x 98cm
EZV05	Tile Flashing 78cm x 98cm



WHAT'S ON OFFER?

UPVC Pitched Roof Windows

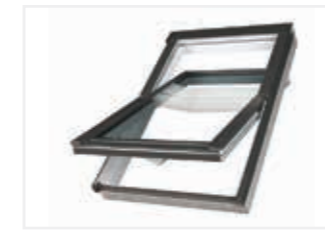

UPVC Centre Pivot Roof Window (PTP-V)

- Pivots from the centre when opened.
- Pure White PVC finish as standard.
- topSafe anti-burglary system as standard.
- V35 Air Inlet for ventilation.
- 10 Year warranty.
- Option of Golden Oak & Pine Veneer.



UPVC Top Hung & Centre Pivot Roof Window (PPP-V)

- Pivots from top or centre when opened (preSelect dual function)
- Pure White PVC finish.
- topSafe anti-burglary system as standard.
- V35 Air Inlet for ventilation.
- 10 Year warranty.
- Option of Golden Oak & Pine Veneer.

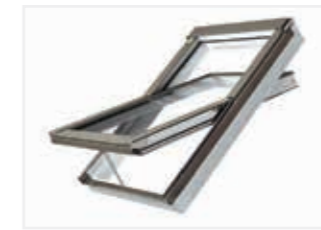

UPVC Electrically Opening Roof Window (PTP-V Z-Wave)

- Pivots from the centre when opened.
- Electrically operated.
- Pure White PVC finish.
- topSafe anti-burglary system as standard.
- V35 Air Inlet for ventilation.
- 10 Year warranty.
- Option of Golden Oak & Pine Veneer.

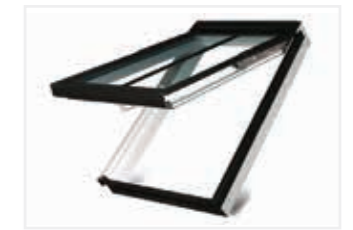

Conservation

- Conservation options available across our entire UPVC range.
- Conservation windows are designed for use in conservation areas which are worthy of preservation due to historical interest.
- The main difference is they're finished in Jet Black & have a glazing bar fitted.

Internal & External Accessories

We have a full range of internal and external accessories available. Please see some of our most popular choices.



ARZ Shutter

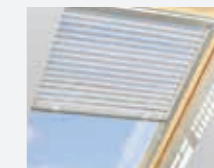

AJP Venetian Blind



ARF Blackout Blind



XDK - Insulation Set

Flashing Kits for Pitched Roof Windows



EPV Plain Tile Flashing Kit

Suitable for non-interlocking plain tiles up to 16mm in profile on roof pitches between 25-90 degrees.



ELV Slate Tile Flashing Kit

Suitable for non-interlocking slate tiles up to 8mm in profile on roof pitches between 15-90 degrees.



EZV-A Interlocking Tile Flashing Kit

Suitable for interlocking tiles up to 45mm in profile on roof pitches between 15-90 degrees.



EHN-A Interlocking Tile Flashing Kit

Suitable for interlocking tiles up to 120mm in profile on roof pitches between 15-90 degrees.

Flat Roof Windows

We also have a fantastic range of flat roof windows available.

- Available in fixed-shut, manually opening & electrically opening.
- Suitable for roof pitches between 2 – 15 degrees.
- Joining gutters available on request.
- Hinges located on the short side of the window.

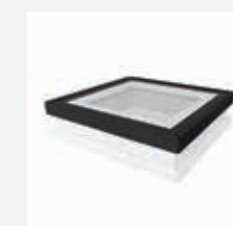

DXG



DMG



DEG

illuminate your world

Luma aluminium flat rooflights

Made-to-measure.
Easy to install.

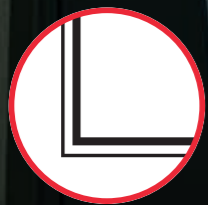

Rigid slimline aluminium profile

The visible framework is minimised, and daylight is maximised.



Secured from the inside

Fixed from the inside for added security.



Double or Triple glazed options

Laminated high performance self-cleaning glass.



U0.9

Excellent energy efficiency

Thermally broken frame and U-values as low as 0.9.³



10
YEAR

10-year guarantee

For peace of mind.

Order in-branch or online
eurocell.co.uk/luma

1. Subject to maximum glass area of 2.5m² (double-glazed) / 2m² (triple-glazed). May also be subject to Eurocell's handling restrictions.
2. Extended lead times apply
3. U-values of 1.3 W/m²K for double and 0.92 W/m²K for triple-glazed.

Thermally broken and glazing options for excellent energy efficiency

Luma's aluminium frame has an integrated thermal break, which reduces heat transfer. And it's available in double-glazed and triple-glazed options, with U-values of 1.3 W/m²K for double and 0.92 W/m²K for triple-glazed. So, you'll stay cool in summer and warm in winter and save money on energy bills.

1. Tinted laminated glass options

Luma is available with either neutral or blue tinted glass. Tinted glass still allows the light to flood in but reduces uncomfortable glare when the sun hits the glass.

2. Secured from the inside

Exclusive to Luma

The only flat rooflight which is fixed from the inside for added security.

3. Slimline modern profile with sleek seamless glazing

Exclusive to Luma

Luma's sleek aluminium frame and unique glazing tape mean there are no chunky frames or painted borders. And there are no bars across the glass to impede your view either. The inside is beautifully finished with a PVC plasterboard trim. The result is minimal framework and maximum daylight.

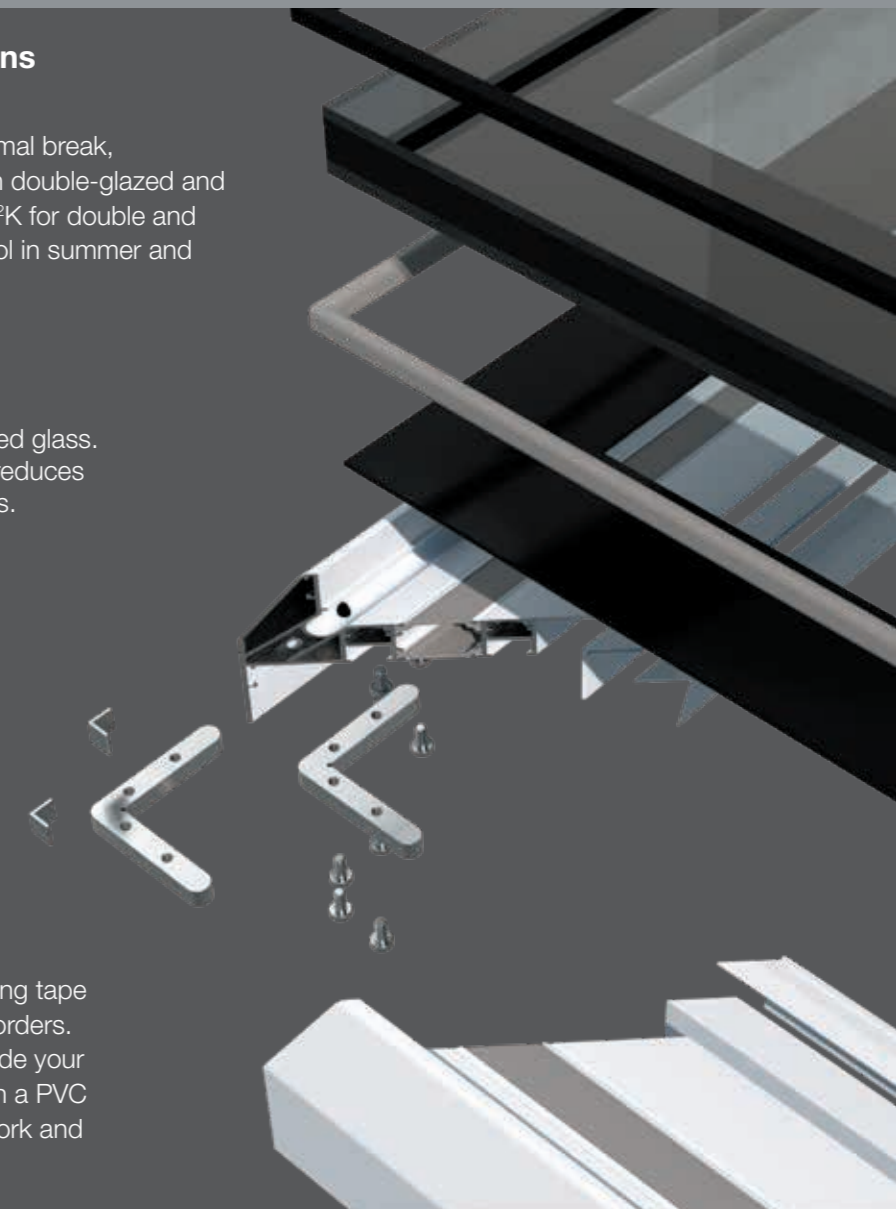

Integral drainage system

Exclusive to Luma

The outer frame includes a unique drainage system that allows moisture to drain away outside for added reassurance.



High performance self-cleaning glass

Luma features self-cleaning glass. It has a special coating that uses UV rays to break down organic matter on the surface, which then washes away when it rains. So, the glass stays cleaner for longer, and the need for regular washing is significantly reduced.



Better by design

Here at Eurocell, we believe you should never have to compromise on quality or performance when you make improvements to your home. That's why innovation is at the heart of our Luma flat rooflights. We've built-in exclusive, market-leading features that come as standard to bring you a premium-quality product that performs excellently.

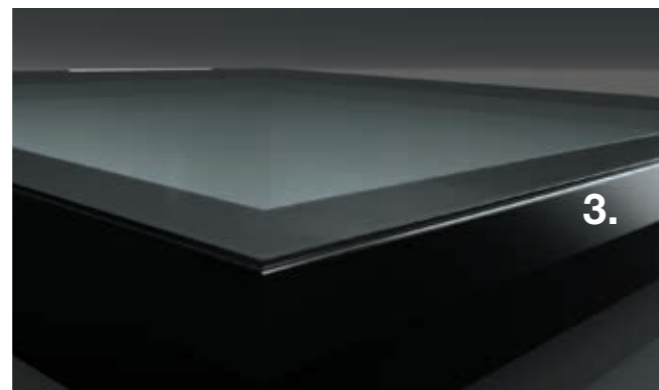
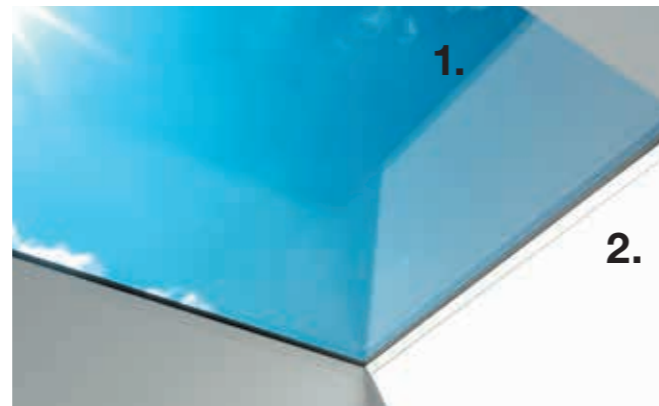

Future Homes Ready

Building Regulations are changing. In 2025 a new Future Homes Standard will be introduced, which requires all new homes to be future-proofed with low-carbon heating and world-leading levels of energy efficiency. So, we've designed Luma flat rooflights to be Building Regulations compliant. Not just for now but for the future too.

ARE YOU AN INSTALLER?

Easy to install and delivered straight to site

Luma flat rooflights are made to order in our factory, then delivered straight to site. They're easy to install, helping you complete the job quickly, with no fuss and no mess.

Our service promise to you

We know how important it is to you to keep your customers happy. That's why we take great pride in consistently providing a friendly, approachable service to make finding and getting what you and your customers need quick and easy. Here's how we help:



Quotes in under 1 hour

There's no waiting around. Just call, drop us an email or fill in the contact form on our website to request a quote, and we'll respond within an hour.⁵



Lead times to suit you

Tell us when you need the products to be on site, and we'll ensure they're there at the right time.



Order checking

Our orders are thoroughly checked prior to delivery, allowing you to get on with installing Luma right away.



Technical support line

Luma flat rooflights are easy to install, but if you need help, our expert technical team are just a phone call away.



To find out more, ask our experts at your **local Eurocell branch**. Alternatively, simply call us on **0333 005 6525**, email us at **enquiries@eurocell.co.uk** or visit:

eurocell.co.uk/luma

4. Installation at 5° pitch is recommended
5. Applies within normal office working hours: Mon-Fri 8.30 - 17.00

Rooflights

- Rooflights are an ideal way to increase natural light on flat roof properties.
- This product range offers high security and exceptional energy efficiency - with u-values as low as 1.8!
- The domed design offers great aesthetics, meaning they are desirable additions for residential and commercial applications.



OTHER DESIGNS AVAILABLE

GLAZING OPTIONS

- CLEAR**
 - High light transmission
 - Allows unimpeded views
- OPAL**
 - High light transmission
 - Allows unimpeded views
- DIFFUSED**
 - Maximises privacy
 - Diffuses light to avoid sun glare
- BRONZE**
 - Reduces solar heat gain
 - Reduced light-transmission

Choice of ventilation options - ask a member of staff at your **local Eurocell branch today!**

GET A TRADE ACCOUNT TODAY

ASK IN BRANCH FOR MORE DETAILS



over 6000 products in branch



200+ branches nationwide

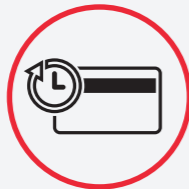

Trade credit available*



Dedicated account manager



Exclusive trade account pricing



Online trade account

* Trade accounts are subject to T&Cs and acceptance.

Flat roof windows

Fakro flat roof window

- The Fakro type G product range includes flat roof windows which are non-opening (DXG), manually opening (DMG) or electrically operated (DEG). Fakro flat roof products bring the very highest standard of natural light to interiors. They also provide ventilation and offer exceptional functionality. In short, they can transform any room under a flat roof.
- The new range of technologically advanced G windows give smart aesthetics and provide an alternative solution for bringing natural daylight into rooms below a flat roof.
- Integral upstand for quick and easy installation.
- P2 safety glazing
- 10 year warranty

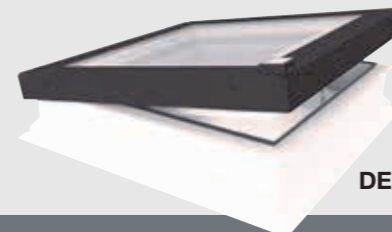

DEG

- ### Electric z-wave control
- Electrically opened with wireless Z-Wave system,
 - Included in the kit: AC adaptor, remote control, rain sensor
 - Sash tilts 15cm

Code	Size
FRW80EX01	01K 60x60
FRW80EX02	02K 60x90
FRW80EX03	03K 70x70
FRW80EX04	04K 80x80
FRW80EX05	05K 90x90
FRW80EX06	06K 90x120
FRW80EX07	07K 100x100
FRW80EX08	08K 120x120
FRW80EX09	09K 140x140
FRW80EX10	10K 100x150
FRW80EX11	11K 120x200

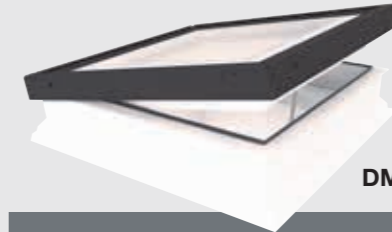

DMG

- ### Manual opening
- Opened manually by means of ZSD control rod 2.2m long included
 - Sash tilts 30cm

Code	Size
FRW80EW01	01K 60x60
FRW80EW02	02K 60x90
FRW80EW03	03K 70x70
FRW80EW04	04K 80x80
FRW80EW05	05K 90x90
FRW80EW06	06K 90x120
FRW80EW07	07K 100x100
FRW80EW08	08K 120x120
FRW80EW09	09K 140x140
FRW80EW10	10K 100x150
FRW80EW11	11K 120x200

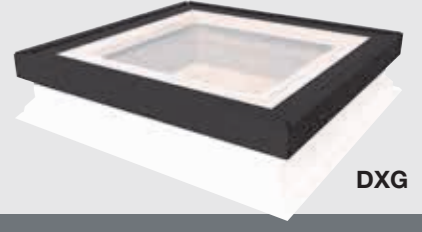

DXG

- ### None opening
- Non-opening

Code	Size
FRW80EU01	01K 60x60
FRW80EU02	02K 60x90
FRW80EU03	03K 70x70
FRW80EU04	04K 80x80
FRW80EU05	05K 90x90
FRW80EU06	06K 90x120
FRW80EU07	07K 100x100
FRW80EU08	08K 120x120
FRW80EU09	09K 140x140
FRW80EU10	10K 100x150
FRW80EU11	11K 120x200

Doors

DOORS

CONTENTS

Composite doors	46
PVC-U doors	54
PVC-U door canopies	58
Door surrounds	59
Sliding patio doors	60
PVC-U bi-fold doors	62
Aluminium bi-fold doors	64
French doors	66
Colour options	68
Garage doors	70



High security, low-maintenance and attractive composite, PVC-U and garage doors available in a range of colours and styles

- **Dales Doors**
Our collection of composite doors is better than ever with 22 styles available in classic, period and contemporary designs.
- **PVC-U Bi-fold doors**
Why not open yourself up to a new business opportunity? Aspect are a hit with customers - so why not start installing them today.
- **Aluminium bi-fold doors**
Studioglide isn't just a winning combination of high performance and thermal efficiency. Quality materials and advanced design make for a smooth, reliable sliding mechanism and frames that won't expand or contract, whatever extremes the weather throws at them.
- **Syncro sliding patio doors -**
A slim and attractive patio door - a perfect addition to your offering.



Dales collection composite door



PVC-U Bi-fold doors



Studioglide Bi-fold doors



Syncro sliding patio doors

Design choices

Dales Doors offer a superb range of colours and styles to meet your customers' needs.

With Eurocell's composite doors, worries about unwanted intruders disappear. PVC-U edge banding comes as standard. A five-point locking system paired with a one-star cylinder with a two-star handle (delivering a three-star solution) reinforces its security credentials. Plus, choose to have our composite doors Secured by Design, which are above 'Police Preferred Specification' in independent tests.

Use our door configurator to design your door.

How to design your perfect door

Creating your new door is simple. The first step is to choose a door that fits your style. Then pick your perfect colour, add glazing if required, and then add your finishing touches. The following pages take you through all the options available to create your perfect door.



DESIGN YOUR DOOR AT:
designyourdoor.co.uk



Step *one* Choose your door

CLASSIC STYLE



PERIOD STYLE

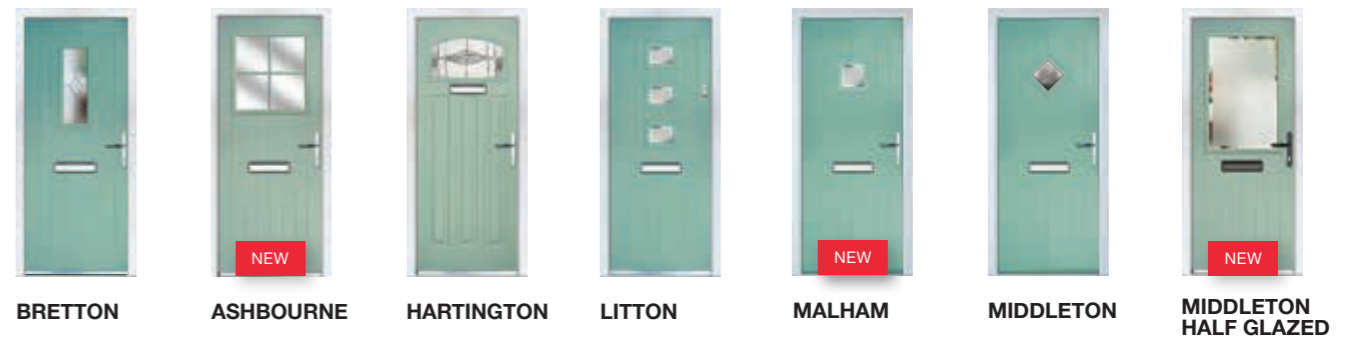

CONTEMPORARY STYLE



Design choices

Step *Two* Choose your colour

All doors come with White internal colour as standard. However you can choose to have colour on both sides if that's your style choice.

STANDARD COLOURS



PREMIUM COLOURS

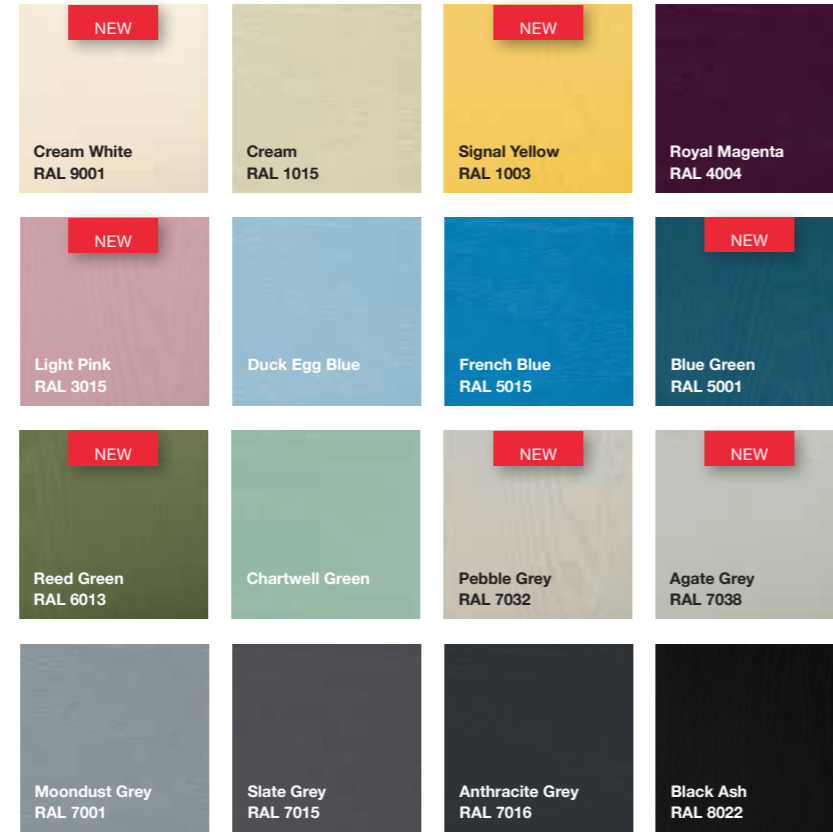

Step *Three* Choose your frame colour

Frames can be coloured both sides on request and can also be sprayed in any classic RAL colour with either a smooth or foiled finish.

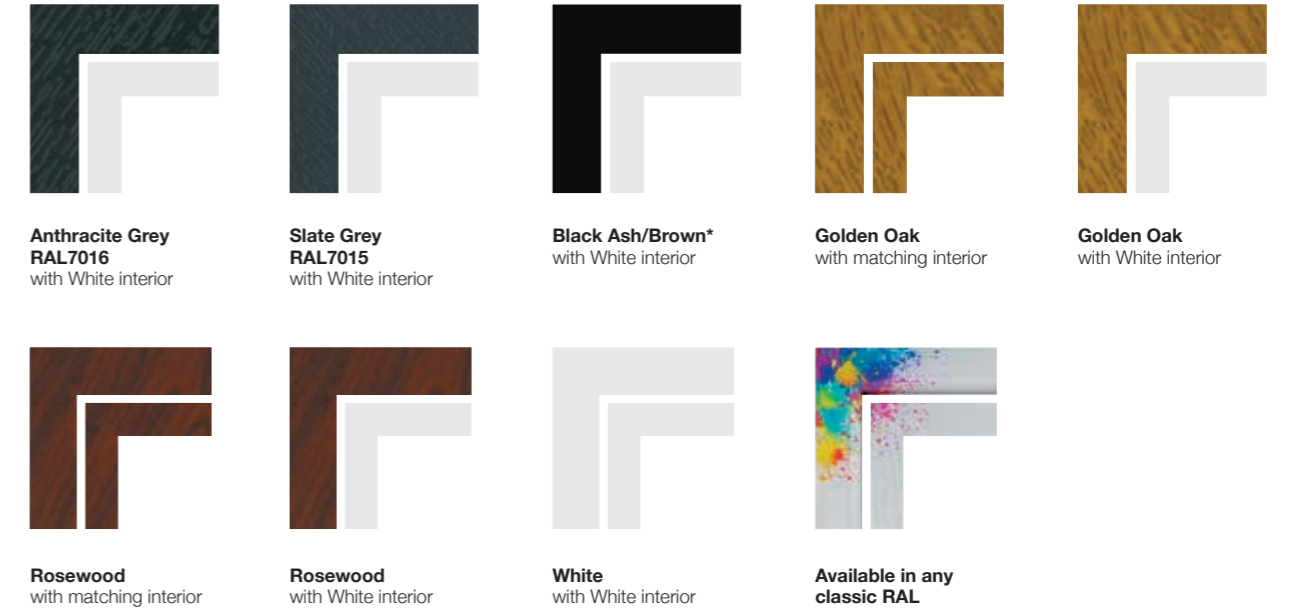

* The foiled Black Ash/Brown frame may appear lighter than the black door in direct sunlight

Can't see your perfect colour?

Don't worry! All our doors can be sprayed in any classic RAL* colour

*additional cost and lead times apply



Design choices

Step *four* Choose your glass

Beauty that shines through

You can choose from bold half-glazing, through to contemporary arches and traditional glazing infused with decorative picture art. From traditional designs to abstract geometric shapes and colourful glass options, we're sure to have a design for you. Our wide range of glazing options enables you to add the finishing touch to your door and complement your home. All of our glass designs are made using the highest quality materials, so glass colours will remain bright and vibrant for years to come. Manufactured using traditional techniques and finished by hand, our glass options offer the best possible finish.

Triple-glazed units

We offer an extensive range of triple-glazed glass in many stunning designs including some Gold and Silver lead options. Constructed using hand-cut bevels and textured glass pieces, triple-glazed units are beautiful additions to any door design. What's more, they offer excellent thermal and sound insulation properties, as well as providing extra security thanks to the additional strength.

GLAZING OPTIONS

AS LITTLE AS
5 DAYS
LEAD TIME

If you choose a door that doesn't require a top or sidelight, we'll deliver it within 5-10 days. This includes doors with triple glazed units. All glass units have clear glass on the outside with your choice of backing glass in the centre as shown in the diagram below. Backing glass options are not available on triple glazed units.

Glass configuration



Creating *privacy*

Many of our glass designs can be specified with different backing glass as well as clear, offering varying levels of obscurity. Choosing the right backing glass can help increase the level of privacy your door offers, as well as match glass elsewhere in your property.

BACKING GLASS OPTIONS

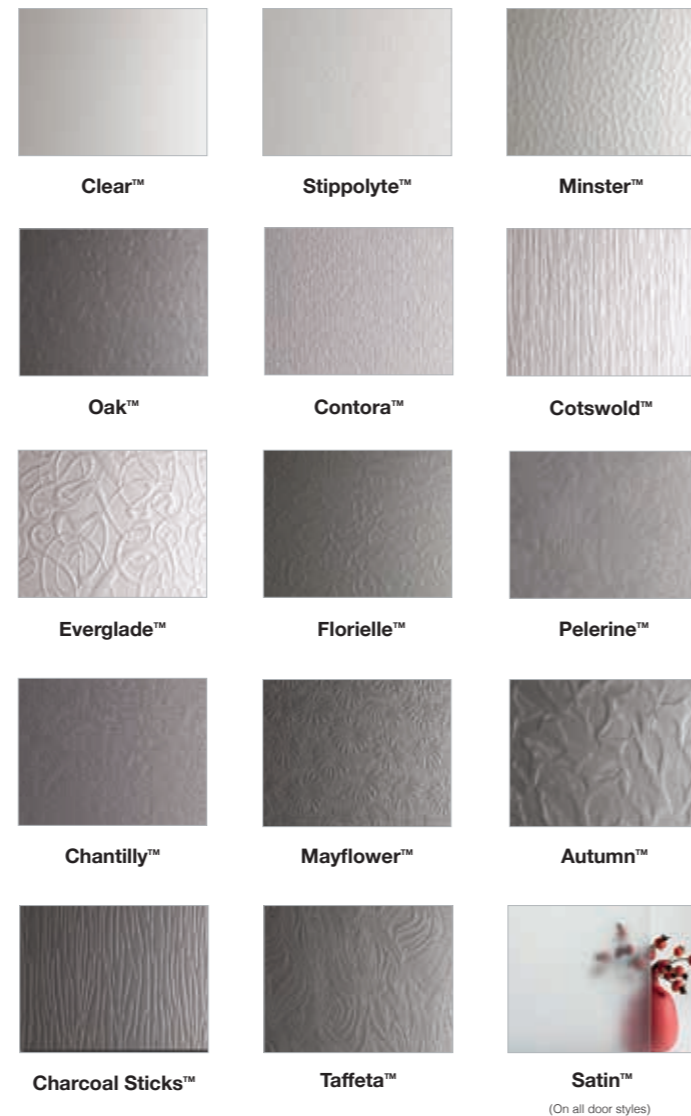

© Images reproduced by permission of Pilkington plc

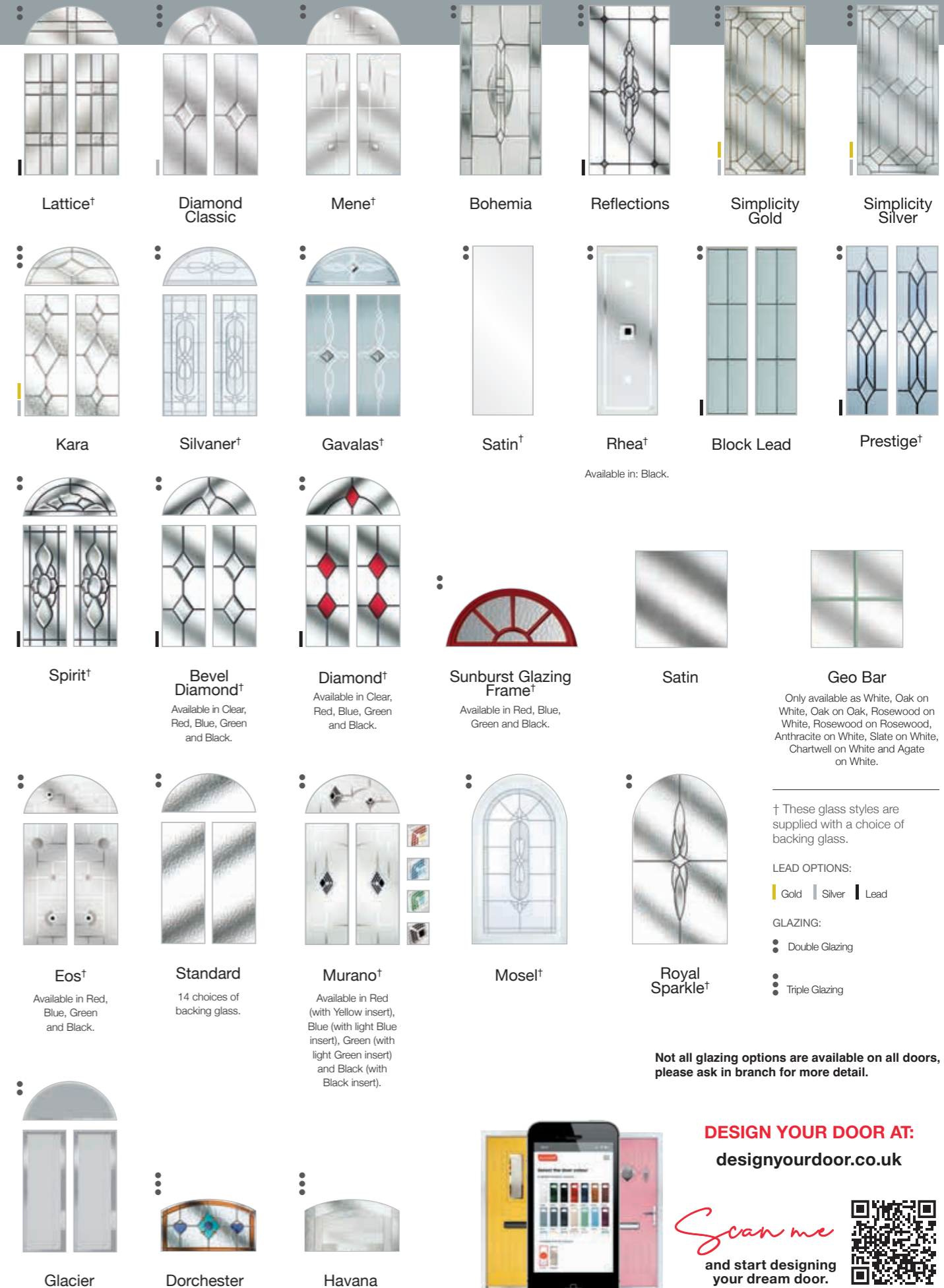

Available in: Black.

† These glass styles are supplied with a choice of backing glass.

LEAD OPTIONS:
Gold | Silver | Lead

GLAZING:
● Double Glazing
● Triple Glazing

Not all glazing options are available on all doors, please ask in branch for more detail.



DESIGN YOUR DOOR AT:
designyourdoor.co.uk

Scan me
and start designing your dream door.



Design choices

Step *five* Choose your finishing touches

//HANDLES AND BARS

Lever / lever (split spindle)
Lever / lever (through spindle)



White

Gold

Chrome

Satin Silver

Satin Black

Cast Iron Effect (Black)

Long bar
Long Bar (1200mm) int & ext*
Long Bar (1200mm) ext only**



Satin Silver

Short bar
Short Bar (600mm) int & ext*
Short Bar (600mm) ext only**



Cylinder pull





Gold

Satin Silver

Chrome

*Internal and external face of door
**External face of door only

//LETTERBOX



White

Gold



Chrome



Satin Silver



Satin Black



Cast Iron Effect(Black)

//HINGES

White



Black

Gold*

Chrome*

*not available on open out doors

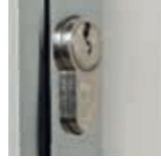
//LOCK





Multi-point lock



//KNOCKERS

Standard



White

Gold

Chrome







Satin Silver



Satin Black

//OTHER OPTIONS

Numbers
Available in White, Gold, Chrome, Satin Silver and Satin Black.



Spyhole
Available in White, Gold, Chrome, Satin Silver and Satin Black.



Door chain
Available in Gold and Chrome.



Colour-matched weather bar
Available in Red, Blue, White, Black, and Green.



Painted weather bar
Available in Anthracite Grey, Brown, Caramel, Chartwell Green, Cream, Duck Egg Blue, French Blue, Royal Magenta, Moon dust Grey, and Slate Grey.

//CILL OPTIONS

If required:	Size	Length	Size	Length
Available in White, Oak, Rosewood, Anthracite Grey, Slate Grey and Black Ash.	85mm	1100mm	150mm	2100mm
	85mm	2100mm	180mm	1100mm
	150mm	1100mm	180mm	2100mm

Please note:
If a cill option is chosen a metal Part M compliant threshold will be supplied.

//FRAME EXTENSIONS

If required:	Size	Length
White, Oak, Rosewood, Anthracite Grey and Slate Grey.	15mm	1100mm
	15mm	2100mm
	25mm	1100mm
	25mm	2100mm
	50mm	1100mm
	50mm	2100mm

Don't forget to

complete the look

COMPOSITE SIDELIGHTS

For homes with larger openings, we offer a range of sidelight options to complement your door.



Design your perfect door at...
designyourdoor.co.uk



Scan me
and start designing your dream door.

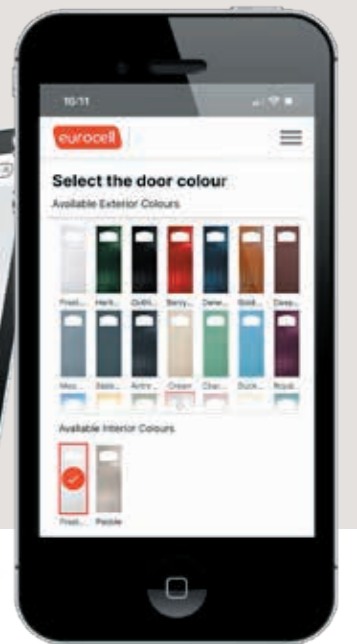

Note: All Chrome, Gold and Satin Silver handles, knockers and letterboxes are stainless steel.

the elegance collection

VERSATILE DOORS THAT WILL ENHANCE ANY HOME

Extensive choice of attractive, hard-wearing doors in a choice of styles

High levels of security

A range of glazing options available

Thermally efficient

Heat and moisture resistant

Inverted designs also available



Victorian



Windsor

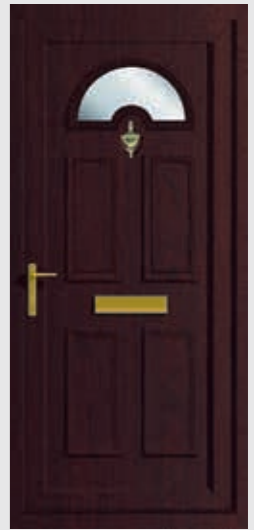

Georgian



Cornwall



Edwardian



Regency

DOOR PANEL AND FRAME COLOURS (ALL WHITE INSIDE FOR BOTH)



WHITE

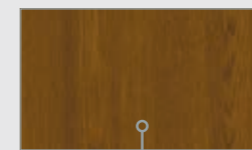

GOLDEN OAK

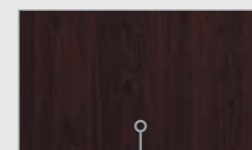

ROSEWOOD

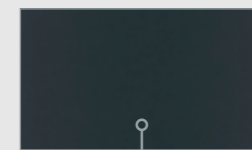

ANTHRACITE GREY
RAL 7016



CHARTWELL GREEN
RAL 6021

PVC-U Doors - glass & hardware

GLAZING STYLES AVAILABLE

may vary with door style



OBSCURE GLAZED



GEORGIAN BAR

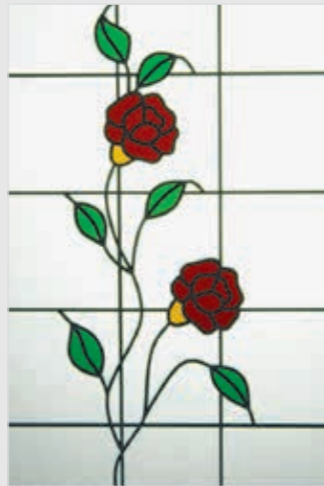

CLIMBING ROSE

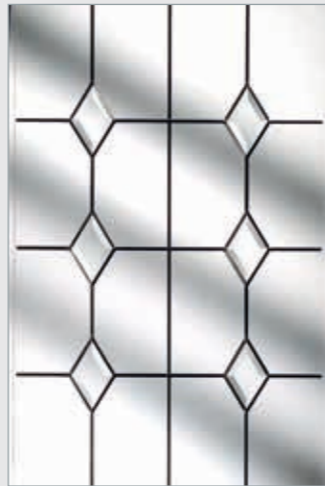

BEVEL CLUSTER

STAINLESS STEEL FURNITURE

LETTERPLATES



BLACK

GOLD

CHROME

SILVER

WHITE

URNS



BLACK

GOLD

CHROME

SILVER

WHITE



BLACK

NUMBERS AND LETTERS (A-D ONLY)



GOLD

SPYHOLES



BLACK

GOLD

CHROME

WHITE



CHROME



YOUR ONE-STOP SHOP

GET A TRADE ACCOUNT TODAY AND GET A WHOLE LOT MORE.

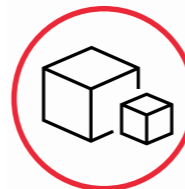

over 6000 products in branch

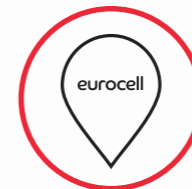

200+ branches nationwide

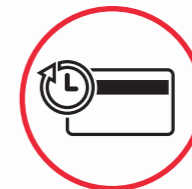

Trade credit available*

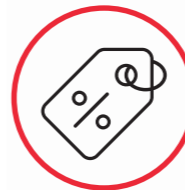

Exclusive trade account pricing



Online trade account



Dedicated account manager

* Trade accounts are subject to T&Cs and acceptance.

SIGN UP TODAY. ASK IN BRANCH TODAY FOR MORE DETAILS.



Shop 24/7
eurocell.co.uk



Click & collect
in branch



Free onsite
delivery**



**Free onsite delivery on orders over the min. spend - Longer lead times apply to made-to-order items. Applies to mainland UK only and excludes Northern Ireland & Northern Scotland.

PVC-U door canopies



Get quick quotes on our MTO products

IDEAL FOR NEW BUILD AND REFURBISHMENT PROJECTS

Suitable for a variety of entrance doors

Designed GRP material is low-maintenance - it will never need repainting!

The ripley



Flat top, lead-look canopy with scalloped edge and Georgian period detailing will add prestige to any property

Code	Size
RIP 1500	1500mm

Colour options:
WH White

The cheltenham



This strong, rigid GRP dual pitch canopy with tile effect roof and imitation woodgrain detailing is available with 3 design options on the gable

Code	Style
CHELT 730	730mm std
CHELT 730F	730mm fleur
CHELT 730T	730mm t-bar

Colour options:
WH White

The rockingham

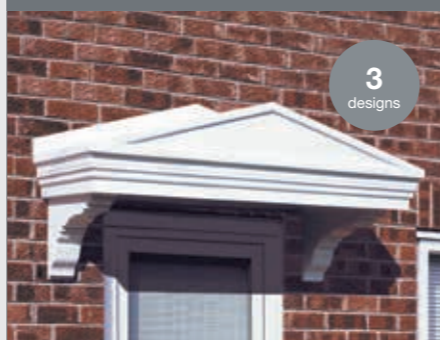

Elegant Victorian style GRP door canopy incorporating fully moulded brackets offers a period look for your customers

Code	Style
ROC B	With brackets
ROB WB	No brackets
ROC CL	Lead-top effect

Colour options:
WH White

Door surrounds

THE VICTORIAN



Get quick quotes on our MTO products

Add prestige to entrance doors

Code	Colours
VTPS	WH White

THE GEORGIAN



Get quick quotes on our MTO products

This regal design will enhance any doorway

Code	Colours
G TPS	WH White

FREESTANDING COLUMNS

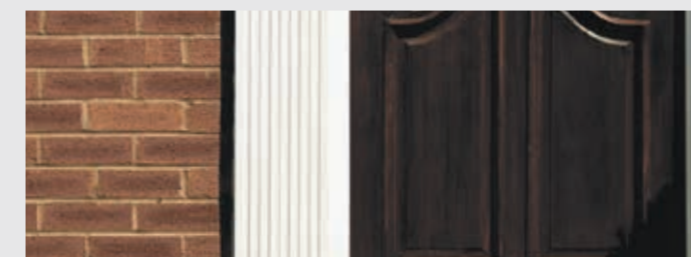









The finishing touch to entrance doors

Code	Style
FP	Flat pillar
COLPL	Plain column
RCOLFLU	Fluted column

Colour options: WH White







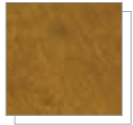

Features & Benefits

 Width of up to 3.5m available	 Fast, accurate fabrication and installation	 Soft-close option	 U1.0 WITH ARGON GAS U-values as low as 1.0*
 Wide range of colour and style options including grey substrate option	 Triple glazing compatible	 Delivery from 6 working days	 10 YEAR 10-year guarantee for peace of mind**

* Lower U-values are achievable with Krypton gas. ** White profiles only

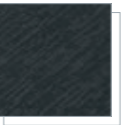
Colours from Stock

 WHITE White interior	 GOLDEN OAK White interior	 GOLDEN OAK Both sides	 ROSEWOOD White interior	 ROSEWOOD Both Sides	 ANTHRACITE GREY White interior	 ANTHRACITE GREY Both sides Grey base	 ANTHRACITE GREY SMOOTH Grey base
---	--	--	--	--	---	--	---

Say hello to Syncro sliding patio doors. Relax in understated style with Syncro. The soft-close feature keeps noise to a minimum. Triple glazing and PAS24 security standards ensure maximum performance. And with each frame made from at least 40% post-consumer waste (PCW), and a grey substrate available for those chasing the modern look, there's no reason to hold back.

Close to perfection in the patio door market Syncro is available to PAS24 standards, which means you can meet Document Q – the newest security regulations for patio doors. Plus, its improved strength, security and weather performance mean it also satisfies BS6375 as standard. But that's just for starters.

- More sustainable with frame composition made up of at least 40% PCW (post-consumer waste)
- Better thermal efficiency with U-values as low as 1.3 for double glazed units and 1.0 for triple glazed

- Maximum width of 3.5m (2 pane) and a maximum sash width of 1750mm
- Triple as well as double glazing compatible for even better insulation
- Grey substrate for total coordination with modern designs
- Soft close option

Made to Order



ANTHRACITE GREY MATT
Grey base

32 Additional colours and specifications are made to order on extended lead times

Note: grey base product features cool colours foil

Handle Colours



WHITE

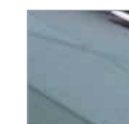









HARDEX CHROME



HARDEX GRAPHITE













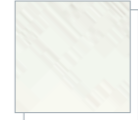

Features & Benefits

 <p>Purpose-designed system for superior performance</p>	 <p>Fast, accurate installation</p>	 <p>Patented features for superior looks</p>	 <p>U1.0 WITH ARGON GAS U-values as low as 1.0*</p>
 <p>BBA certified and Secured By Design approved</p>	 <p>Cheaper than aluminium and timber alternatives</p>	 <p>Bespoke British designed hardware</p>	 <p>10 YEAR 10-year guarantee for peace of mind</p>

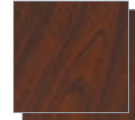
* Lower U-values are achievable with Krypton gas.

Frame Colours

 WHITE White interior	 WHITE ASH Both sides	 WHITE ASH White interior	 GOLDEN OAK White interior	 GOLDEN OAK Both sides	 IRISH OAK White interior	 IRISH OAK Both sides	 ROSEWOOD White interior	 ROSEWOOD Both sides
 ANTHRACITE GREY White interior	 ANTHRACITE GREY Both sides	 BLACK ASH White interior	Additional colours and specifications are made to order on extended lead times					

Hardware Colours

 WHITE	 BLACK	 CHAMPAGNE	 SATIN SILVER	 SILVER GREY	 BRIGHT CHROME
---	---	---	--	---	---

With modern, sleek elegance, panoramic doors are an increasingly popular addition to the latest home and commercial projects, creating a large opening with a low threshold for easy access that makes a stunning difference

Aspect is a high-performance, secure and visually stunning UPVC panoramic door system that's designed for hassle-free fabrication and fitting, whether selecting bi-fold, entrance or flush French doors. Aspect offers all the aesthetic and functional benefits of timber and aluminium alternatives, but at a more affordable price. It incorporates a host of intelligently designed and precision-engineered bespoke components that enable accurate, consistent, straightforward fabrications and installation.







Fully accredited

Eurocell pushes the boundaries of design and performance in the panoramic door category. Our Aspect bi-fold was the first of a few bi-fold doors on the UK market to gain BBA accreditation and Secured by Design status.

Meeting these two important standards means that Aspect bi-fold doors are perfect for all new build applications where SBD is being specified to meet the requirements of Approved Document Q.



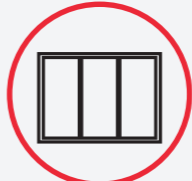
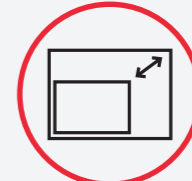

Features & Benefits

 Flexibility	 Fast, accurate fabrication and installation	 Complete range of handles and accessories	 U1.3 <small>U-values as low as 1.3</small>
 Colour options that complement the aesthetic of any property	 Minimal profiles for a modern look and in-line system	 Increased scalability	 10 YEAR 10-year guarantee for peace of mind*

* White profiles only

Standard Frame Colours

 WHITE <small>White interior</small>	 BLACK <small>Both sides</small>	 ANTHRACITE GREY <small>Both sides</small>
--	--	--

Duo Colour Option

 ANTHRACITE GREY <small>White Interior</small>
--

Hardware Colours

 WHITE	 BLACK	 ANTHRACITE GREY	 BRUSHED SATIN	 CHROME
---	---	---	---	--

Studioglide frames are available in a range of classic colours, complemented by shootbolt and door handles in a wide choice of colours and finishes.

Studioglide is our aluminium bi-folding door system with improved narrow sight lines, increased door sizes and slimmer profiles. With so many options and configurations to choose from, Studioglide offers high performance combined with contemporary styling that is perfect for any project, large or small.

Studioglide isn't just a winning combination of high performance and thermal efficiency. Quality materials and advanced design make for a smooth, reliable sliding mechanism and frames that won't expand or contract, whatever extremes the weather throws at them.

Temperatures indoors are kept comfortable too, with a thermal break in the frame that reduces heat loss and high-spec energy efficient glass to reduce energy bills even further.

French doors



Ovolo (Sculptured)

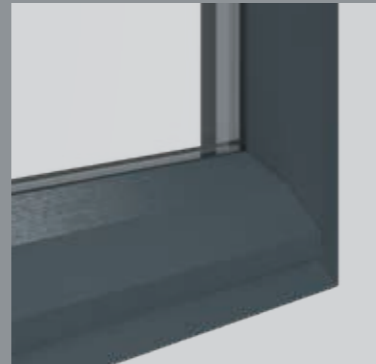

Chamfered (Straight edge)



Flush Sash (Square)

Stylish versatility

Flexible and sophisticated, Lifestyle French doors are available in a range of sizes up to 2 metres wide, providing an impressive entrance to your garden. A tasteful choice of colours allows your doors to complement your home or conservatory. Whether you are looking for classic White or elegant Cream, or if you prefer the natural appearance of Rosewood or Golden Oak, we have a style that's right for you.

Individual design

A choice of frame styles – Chamfered or Ovolo and a choice of opening options mean you can tailor the finish of your French doors to your individual taste. Inward opening allows you to make the most of your patio space or you can maximise your indoor areas with an outward opening mechanism.

Flush French doors

The flush option

Offering all the benefits of French Doors, our flush option replicates a timber aesthetic giving a beautiful finish to any home without the need for regular maintenance. The design of our flush French Door means it perfectly suites into traditional or more contemporary properties and the extensive range of colour options available allows you greater variety to reflect your personal style.



Colour options

aspect BI-FOLD DOORS / FLUSH FRENCH DOORS



logik FRENCH DOORS



HARDWARE COLOURS



HARDWARE COLOURS



† Ovolo only * Chamfered only
Note: Anthracite Grey with Grey base features cool colours foil

studioglide ALUMINIUM BI-FOLD DOORS

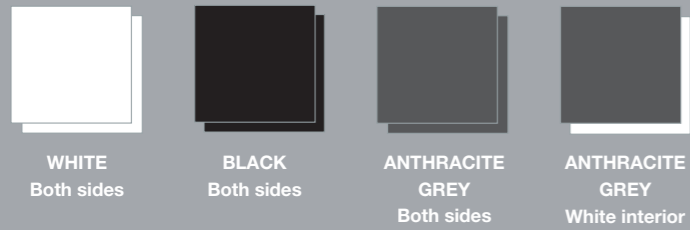

HARDWARE COLOURS



† Ovolo only * Chamfered only * MTO
Note: Anthracite Grey with Grey base features cool colours foil

syncro PATIO DOORS

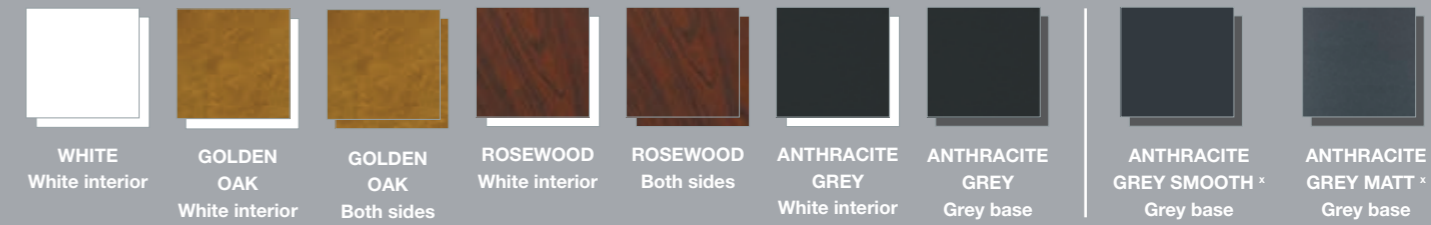

HARDWARE COLOURS

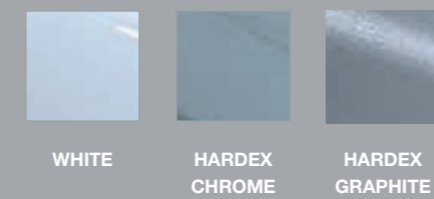

Garage doors



STRONG, SECURE AND LIGHTWEIGHT GARAGE DOORS - SUITABLE FOR EVERY HOME!

High quality, low-maintenance design

Glazing available on certain styles

Two-point locking as standard on Up & Over doors

Full range of sizes including single (7'0, 7'6 and 8'0 wide) and doubles (up to 14'0)

Superior lifting gear on Up & Over doors

Choose from up to 19 colours

**SECTIONAL
& ROLLER
DOORS
AVAILABLE**

GARADOR GARAGE DOORS

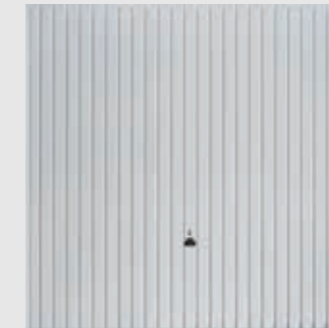

Carlton

- Steel Up & Over Door.
- Low maintenance.
- Choice of 19 colours.

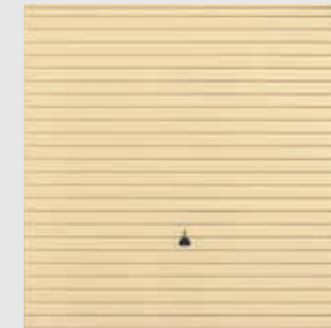

Horizon

- Steel Up & Over Door.
- Low maintenance.
- Choice of 19 colours.

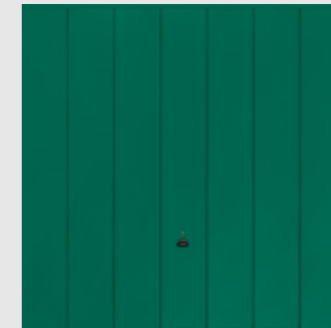

Windsor

- Steel Up & Over Door.
- Low maintenance.
- Choice of 19 colours.

Add a quick fit steel frame

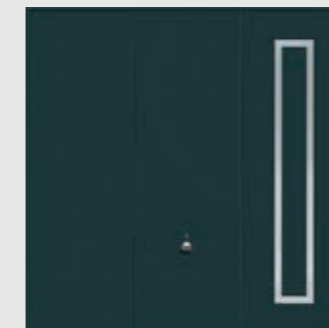

Design 210

- Steel Up & Over Door.
- Brushed steel handle.
- Plus, Anthracite Grey colour option.

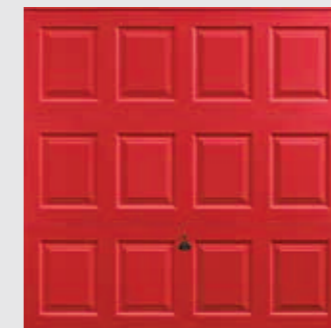

Georgian

- Steel Up & Over Door.
- Perfect for modern & traditional homes.
- Choice of 19 colours.

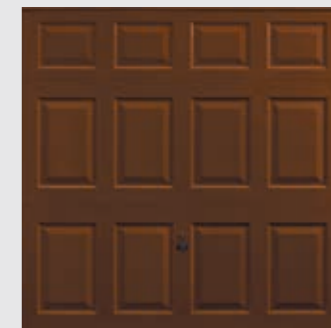

Beaumont

- Steel Up & Over Door.
- Low maintenance.
- Canopy or track gear.
- Choice of 19 colours.

Choose from 19 colours

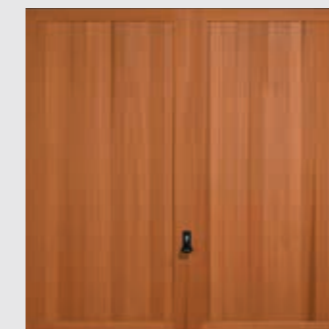

Kingsbury

- Timber Up & Over Door.
- Constructed from solid red cedar.
- Choice of 6 stain options

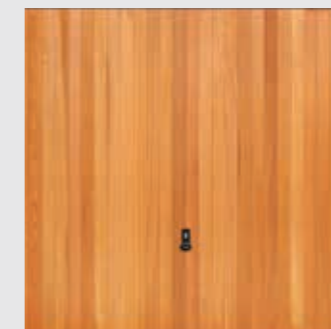

Vertical Cedar

- Timber Up & Over Door.
- Constructed from solid red cedar.
- Choice of 6 stain options

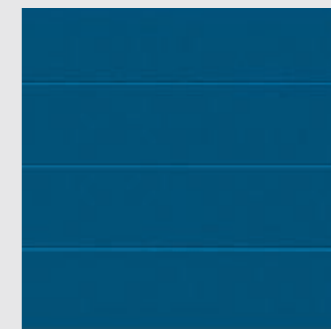

Linear Large

- Sectional Door.
- Full drive through width and height.
- 42mm thick insulated design.

Automate your garage door



Up & over doors



Roller doors



Sectional doors



Side hinged doors

Hardware

CONTENTS

Locks	74
Handles - door	79
Hinges	79
Letterplates	79
Centre strikers/cases	80
Handles - window	81
Restrictors	82

- Eurocell offers a wide selection of Door Hardware, Window Hardware, Additional Security, Architectural Ironmongery and Tools for repair and maintenance.

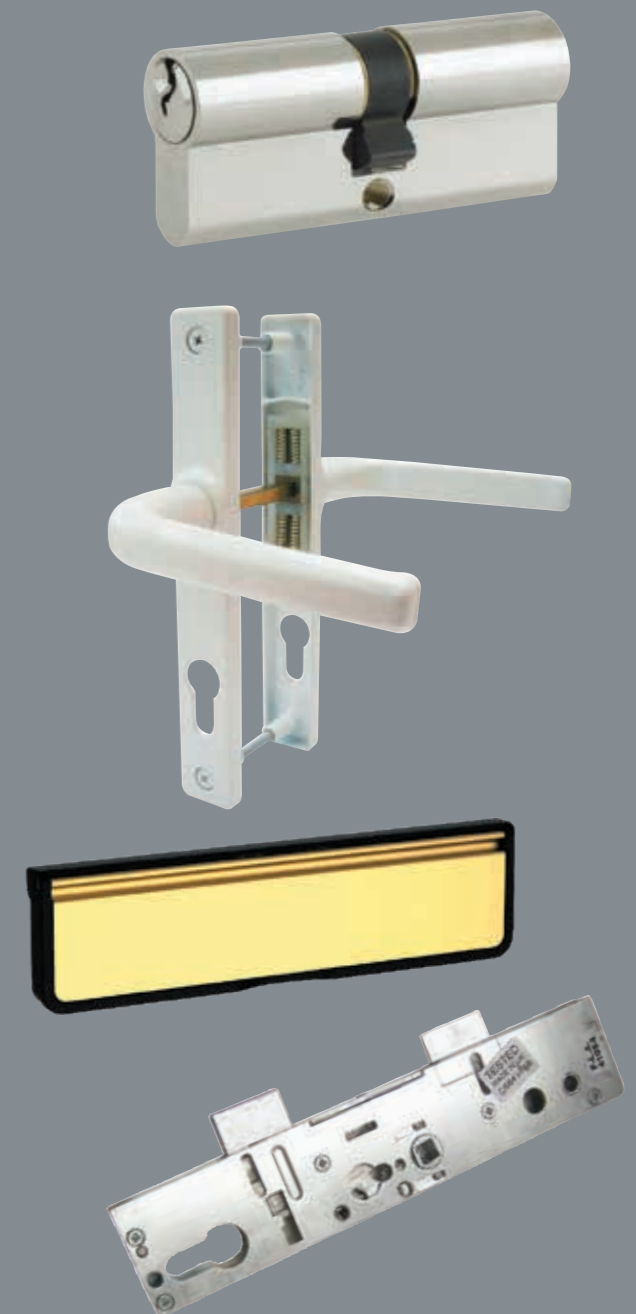

THE KEY TO HASSLE-FREE LOCK REPLACEMENT IS IN YOUR HANDS



Don't let your customers fall victim to insurance company small print

- **QUICK AND EASY REPLACEMENT**
- **INSURANCE RECOGNISED**
- **BS EN 1303 LEVEL**



3 SEPARATE LINES OF DEFENCE

IN STOCK AT YOUR LOCAL BRANCH



DETERS THE MOST DETERMINED ATTACK!

It's a fact that more insurance companies are now specifying that high performance locks such as the Schlosser Cylinder are fitted before paying out claims. Just look at the great built-in security features opposite:

- 1 ANTI-DRILL PROTECTION**
Nickel plated hardened steel key pins and driver pins, gives the anti-drill feature we wanted to incorporate.
- 2 HARDENED GRIP DEFLECTORS**
Make gripping the rest of the cylinder difficult.
- 3 HARDENED REINFORCED BAR**
This is designed not to snap, but to flex in a way that will defeat the majority of intruders.

REPLACEMENT CYLINDER LOCKS

For budget-conscious customers, there is the Euro Profile Cylinder. Available with single cylinder, double cylinder and turn cylinder

EURO PROFILE CYLINDER



- 1** 6-pin Euro profile cylinder
- 2** Quick and easy replacement for existing cylinder
- 3** Tested to BS EN 1303:2005
- 4** Available in polished brass and nickel

EURO CYLINDERS

STANDARD SECURITY	3 STAR SECURITY
<p>VERTICAL KEY NON-HANDED DUAL FINISH 3 KEYS</p> <p>DRILL PROTECTION AS STANDARD!</p> <ul style="list-style-type: none"> ✓ 3 KEYS ✓ DUAL FINISH ✓ NON-HANDED ✓ BS EN1303 STANDARD ✓ VERTICAL KEY ✓ DRILL SAFE PROTECTION 	<p>HORIZONTAL KEY DUAL FINISH 5 BIO KEYS NON-HANDED</p> <p> </p> <ul style="list-style-type: none"> ✓ 5 BIO KEYS ✓ DUAL FINISH ✓ NON-HANDED ✓ BRITISH STANDARD 3 STAR ✓ SECURED BY DESIGN APPROVED ✓ PATENTED PIN DESIGN

SCHLOSSER TECHNIK ANTI-PICK AND ANTI-DRILL EURO CYLINDER

Don't let your customers fall victim to insurance company small print – choose insurance-backed Schlosser replacement locks – in branch now!

3 STAR SECURITY CYLINDER LOCKS



- 5 keys
- Dual finish
- Non-handed
- British Standard 3 star

- Secured By Design Approved
- Patented Pin System

- Anti-drill, anti-pick and anti-tamper**
- Snap safe
- 3* Kitemark

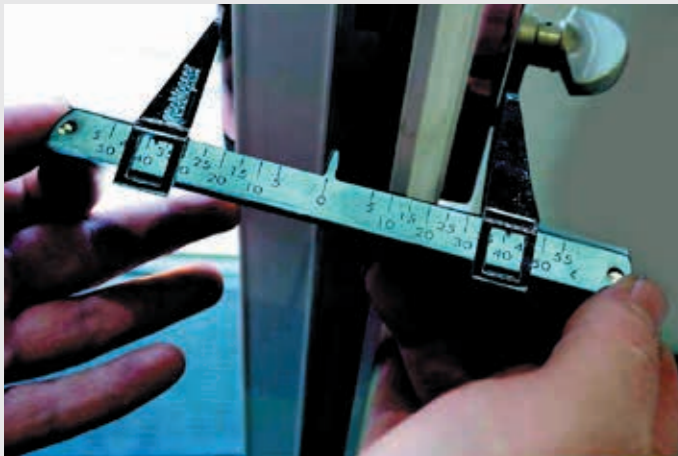

Cylinder Gauge

Cylinder Gauge Measuring Tool in Plastic

Code

ST-CYL-GAUGE

Schlosser Technik 3* Key to Key Euro Cylinder

Tested to BS EN 1303 and supplied with 3 keys

Code	Size
ST-KIN35/35D-K4	35/35
ST-KIN45/55D-K4	45/45
ST-KIN55/45D-K4	45/55
ST-KIN45EX/50D-K4	45EX/50
ST-KIN50/50D-K4	50/50

Schlosser Technik 3* Key to Turn Euro Cylinder

Dual Finish - EN 1303 - 3 Keys

Code	Size
ST-KIN45/45D-K4	35T/35

STANDARD CYLINDER LOCK



Schlosser Technik Key to Key Euro Cylinder

Tested to BS EN 1303 and supplied with 3 keys

Code	Size
UE63535D	35/35 Euro Cylinder
UE63545D	35/45 Euro Cylinder
UE64040D	40/40 Euro Cylinder
UE64045D	40/45 Euro Cylinder
UE64050D	40/50 Euro Cylinder
UE64055D	40/55 Euro Cylinder
UE64060D	40/60 Euro Cylinder
UE64545D	45/45 Euro Cylinder
UE64550D	45/50 Euro Cylinder
UE64555D	45/55 Euro Cylinder
UE65050D	50/50 Euro Cylinder

Schlosser Technik Key to Turn Euro Cylinder

Dual Finish - EN 1303 - 3 Keys

Code	Size
UE635T35D	35T/35 Euro Cylinder
UE640T40D	40T/40 Euro Cylinder
UE650T50D	50T/50 Euro Cylinder



Cylinder Cam Turner

Code

ST-TL-CAMTURNER

SCHLOSSER TECHNIK SNAP-SAFE, ANTI-PICK AND ANTI-DRILL EURO CYLINDER

Don't let your customers fall victim to insurance company small print – choose insurance-backed Schlosser replacement locks – in-branch now!

Locks

PVC-U Door repair lock kit

Kit contains:
 1x four roller multi-point lock,
 1x reversible one piece keep
 8x multi-fit keep packers

- 35mm backset
- Lever / lever, night latch operation
- 92mm PZ centres
- Latch, deadbolt & 4 rollers

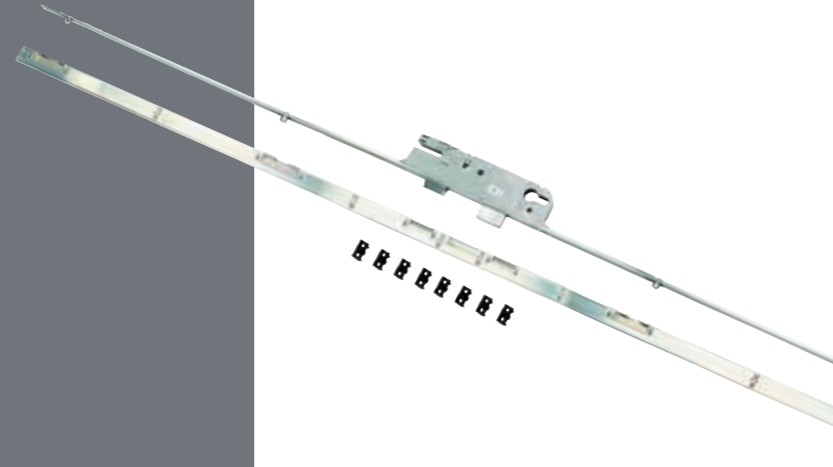

Code	Style
ST-MPL3255P-35LL	35/92 4 Roller repair Lock
FULLEX-REPAIRLOCK	UPVC Universal Repair Lock

PERFECT PARTNER
 Seal trims with
SILICONE SPRAY.



Door Stay

Code	Style
ST-DOORSTAY-UNIVER	90 degree door stay - Rounded Ends includes screws

Hardware

Sparta sprung door handle



Code	Size
ST-DH219	122mm fixing crs/92mm PZ
ST-DH243	210mm fixing crs/92mm PZ
Colour options: MPSS, PVDG Gold, WH White	

Schlosser sprung door handle



Apto L/L 70 Sprung - 180 Fix
 Crs 205 O/A

Code	Size
ST-DH4720	180mm
Colour options: White, Chrome, Gold	

Ideal flag hinge



Ideal Flag hinge to suit sash rebate

Code	Size
ST-HIN0023AXBR-KIT	Brown
ST-HIN0023AXWH-KIT	White

Butt hinges 115mm



Code	Style
ST-HIN6115	0 degree
ST-HIN6116	15 degree
Colour options: BR Brown, WH White	

Letterplates



Letterplate with BLACK ABS frame

Code	Style
ST-DMB1048	Aluminium 10"
ST-DMB1248	Aluminium 12"
Colour options: Options: PG Gold, PS Silver, WH White	

Door Knockers



Universal Fixing

Code

ST-V6MPSS-NANOCOAS

ST-V6PVDG-NANOCOAS

Colour options: MPSS, PVD Gold

Centre cases



Code	Style	Size
ST-MPL3113	Lockmaster PL LDB 2 Followers Centre Case only	35/92/62
ST-MPL3114	Lockmaster PL LDB 1 Followers Centre Case only	35/92
ST-MPL3350CA	Fullex XL 35mm Centre Case - Single Spindle	35/92
ST-MPL3350CA45	Fullex XL 45mm Centre Case - Single Spindle	35/92

Apto cockspur handle 9mm-21mm



Code	Style	Colour
ST-WCH1801PL	Left hand	Gold
ST-WCH1801PL	Left hand	Chrome
ST-WCH1801PL	Left hand	White
ST-WCH1801PR	Right hand	Gold
ST-WCH1801PR	Right hand	Chrome
ST-WCH1801PR	Right hand	White

Colour options: GO Gold, SH Chrome, WH White

Apto cockspur wedge kit



Code	Size
ST-WCH1803	(1x2mm, 1x3mm, 1x4mm & 1x5mm)

Colour options: BL Black, WH White

Schlosser Technik sash blocker non-locking



Code

ST-SJWHITE

Colour options: BR Brown, WH White

Screws



Code	Style	Size
ST-SC39X16PDBAG	Pan Head friction stay screws	3.9x16mm
ST-SC39X25PDBAG	Countersunk Reinforced screws	3.9x25mm

Friction stay hinges with 4mm packer (pair)



Suitable to fit either 13mm or 17mm applications

Code	Style	Colour
ST-WFS5200	Top Hung Friction Stay	13mm x 8"
ST-WFS5201	Top Hung Friction Stay	13mm x 10"
ST-WFS5202	Top Hung Friction Stay	13mm x 12"
ST-WFS5203	Top & Side Hung Stay	13mm x 16"
ST-WFS5204	Top Hung Friction Stay	13mm x 20"
ST-WFS5205	Top Hung Friction Stay	13mm x 24"
ST-WFS5240	Egress Friction Stay with	10.3" x 13mm
ST-WFS5241	Egress Friction Stay with	16" x 13mm

Window espag handle (43mm)



Code	Style
ST-WEH5440-40SP	In-Line locking

Colour options: GO Gold, CH Chrome, WH White

Concealed window restrictor 11.5mm



Code	Style
ST-WR5160LSIKIT-11.5	Left Hung with Stud Plate
ST-WR5160RSIKIT-11.5	Right Hung with Stud Plate

MINI cable restrictor 200mm



Code	Style
ST-WR7210	Colour options: BR Brown, WH White

GET A TRADE ACCOUNT TODAY

ASK IN BRANCH FOR MORE DETAILS



over 6000 products in branch



200+ branches nationwide

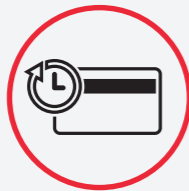

Trade credit available*



Dedicated account manager



Exclusive trade account pricing



Online trade account

* Trade accounts are subject to T&Cs and acceptance.



DESIGNED BY XPERTS. FOR EXPERTS.

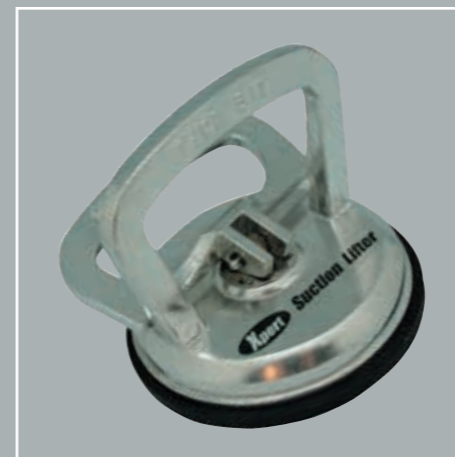



50

YEARS

1974 - 2024

*50 years of lighting up
the industry*



SHOP ONLINE eurocell.co.uk/shop



CALL US 08000 77 88 88



IN BRANCH eurocell.co.uk/branch-finder

eurocell.co.uk

FOLLOW US ONLINE:



**MADE & RECYCLED
IN THE UK**



Product specification is subject to change without notification.
Please also note that colours shown are illustrative only, as the printing process does not allow 100% accurate colours to be reproduced.